

YACHTBEACH

by SPINERA



the inflatable solution
for your yacht

CONTENT

| | |
|-----------------------|----|
| Modular Connection | 8 |
| Platform Teak | 14 |
| Docks | 16 |
| Pools | 28 |
| Hex Platforms | 38 |
| Hex & Square Pavilion | 45 |
| Connector | 60 |
| Steps | 62 |
| Slides | 64 |
| Lounge Products | 70 |
| Custom | 80 |
| Accessoires | 86 |
| Jetxtender | 90 |

YACHTBEACH, a premium brand, brings a new dimension of luxury and convenience to life on the water with its innovative, modular inflatable platforms. Yachtbeach is more than just a platform, it is your gateway to a world of possibilities. Whether you're lounging with friends, extending your yacht's living space, docking your favorite water toys, or creating a custom floating oasis, Yachtbeach offers unparalleled versatility and elegance.

Crafted with superior quality & precision, Yachtbeach combines German engineering with elegance & durability, ensuring every moment spent on the water is unforgettable. The high-quality, durable inflatable products can be easily connected to form various configurations, such as swimming platforms, sunbathing & lounging areas, or docking spaces for jetskis, e-boards, foil boards, dive scooters, tenders, SUPs and more.

Yachtbeach isn't just functional; it's a symbol of innovation and style. Superior surface materials create unmatched feelings & with customizable layouts, and premium accessories – loungers, sunshades, ladders, and more – Yachtbeach turns the water surrounding your yacht into a private haven, perfect for relaxation or entertainment.

Whether you're anchored in a serene bay or enjoying a day at sea, Yachtbeach lets you make the most of every moment.

Ready to enhance your water lifestyle? With Yachtbeach, luxury isn't optional – it's guaranteed. Powered by German engineering and designed with superior surface materials, Yachtbeach delivers unmatched feelings of elegance and comfort. Explore Yachtbeach and start building your custom floating oasis. Your perfect day on the water begins here!



The Global Network of

YACHTBEACH

by SPINERA

YACHTBEACH combines European design, precision engineering, and global expertise to create premium floating platforms and water lounges.

Our products are designed and developed in Germany and Austria, produced with care in China, and distributed worldwide from our logistics centers in Germany, China, and the USA.

This global setup allows us to offer short delivery times, consistent quality, and efficient service — wherever you are in the world.



Designed in Europe Delivered Worldwide

Our Dealers

Global Network • Local Support

With over **100 authorized dealers and service partners** located in the world's most important marinas, YACHTBEACH ensures premium support wherever our customers are.

Our partners not only represent our brand but also provide professional **after-sales service** — guaranteeing that every YACHTBEACH product continues to deliver excellence long after delivery.

Where YACHTBEACH comes to life

- **Germany & Austria**
Global Sales & Marketing
Design & Certification
Engineering & Testing
Warehousing & Distribution
- **Fort Lauderdale**
Sales
Warehousing
Distribution USA, Caribbean, South America
- **China**
Distribution Asia, Australia, Japan

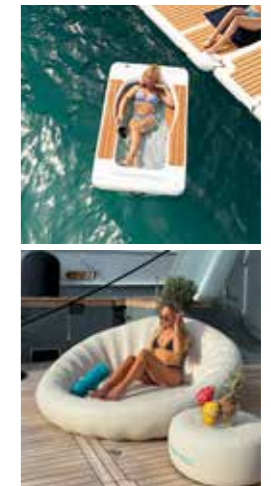
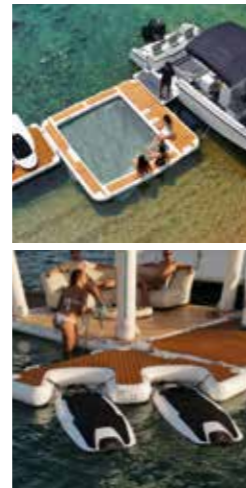

2019

YACHTBEACH launched its journey with the first **floating platforms, pools,** and the **JetXtender** — innovations that defined the foundation of modular water experiences. This year also saw the creation of our **Handle Connection System**, allowing quick, secure, and flexible links between multiple platforms — a key feature that still defines YACHTBEACH today.

2020

Building on our debut, 2020 brought the **Teak Design Pools, the Multi Dock,** and the beginning of our **Air Furniture line.** This year also marked the start of our **water toys and watersport dock** segment — a product category in which YACHTBEACH would soon become a global leader. These developments emphasized refined aesthetics, enhanced usability, and a new level of comfort on the water, reflecting our commitment to merging luxury design with practical, lifestyle-oriented solutions.

2022

Over 2021 and 2022, YACHTBEACH expanded its range with **docks for Jetskis and Foils,** alongside new **Teak Design Platforms.** These products highlighted adaptability and lifestyle-oriented design, catering to modern water sports enthusiasts and private users alike.

2023

In 2023, we introduced a series of landmark innovations: the **Hex System and the first Pavilion Hex,** offering modularity and versatility like never before. Additional highlights included **Slides, always on Stock** program, the **DS Lounger** as well as Accessories such as the Bucket and further development on the **Air Furniture Line** — all designed to elevate the floating experience.

2024

2024 marked a year of expansion with the launch of **Superior Pool Platforms** featuring **8-meter-plus dimensions,** alongside the **Foil Ramp.** These products reinforced YACHTBEACH's position as a leader in large-scale, premium floating solutions. In addition, the platforms were designed to accommodate **sunroofs,** providing shade and enhanced comfort, and further elevating the luxury and usability of our floating experiences.

2025

Continuing innovation into 2025, we introduced a **new Ladder, Steps, the Pavilion Square,** and custom **Pickleball** setups. These additions focused on enhancing usability, customization, and fun on the water, ensuring every platform meets lifestyle and leisure needs.

2026

Looking ahead to 2026, YACHTBEACH will unveil the **In-Water Lounger and Shell Sofa** — products designed for ultimate comfort and relaxation, further blending luxury, modularity, and water-bound living.



YACHTBEACH Handle Connection Systems

Our Yachtbeach Connection Systems allow an easy & fast connection between different Yachtbeach products above the water, which enables multiple connection options. They consist of a buckle and a Velcro, which is especially made for marine use. The buckle provides maximum strength and the crocodile Velcro offers a comfortable aesthetic finish.

HANDLE CONNECTOR PRO

- > Material: 0,9mm 1000D/28x26 Reinforced PVC
- > Inside with 1,5" Stainless Steel Buckle
- > allows for very comfortable and easy to use handling
- > enables multiple connection options
- > quick and easy installation



> 12 point YACHTBEACH handle connection system

FASTENING BELT

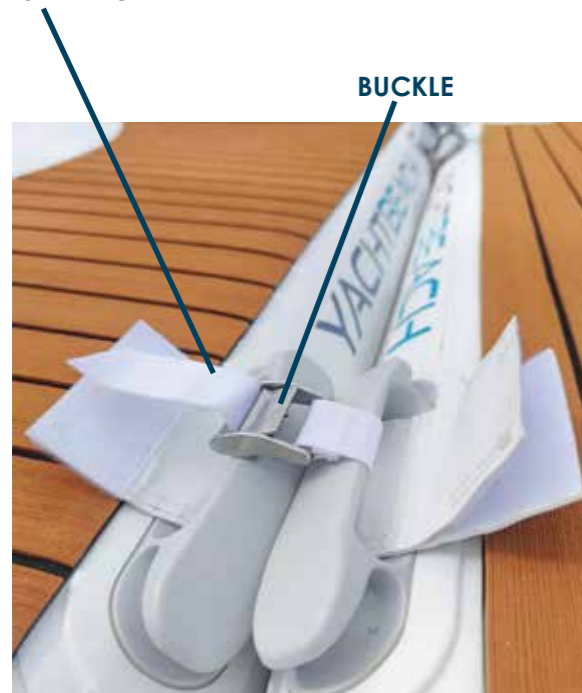

VELCRO



YACHTBEACH 12-point Handle Connection Systems

D-RING CONNECTOR

Provides additional support to the handle connector pro for open sea and usage in wavy places.

- > - Heavy Duty Connection Strap to connect 2 D-Rings
- > - 1.5" Strap, length is about 118cm
- > - Perfect to connect 2 D-Rings with up to 55cm distance
- > - Professional 1.5" Stainless Steel #316 Buckle



YACHTBEACH PLATFORM WITH EVA TEAK DECK

With the new and innovative yacht platforms from YACHTBEACH you can create your own small beach directly at the boat or as an elegant bathing terrace in your pond or lake. This high-end product impresses with its elegant and noble design. With it you treat yourself and your passengers to a perfect bathing island for reading, relaxing and swimming. YACHTBEACH is also the perfect platform for fitness, yoga and mindfulness as well as a floating party lounge for social evenings with friends.

This pieces of freedom can be combined multifunctionally and in various ways. The connection allows the perfect docking station for Jet Ski, Tender, Seabob, SUP and much more.

Characteristics:

- made of 20 cm dropstitch
- very comfortable EVA teak surface
- incl. swim ladder holder
- Incl. D-rings on top for numerous connection options from above surface
- Incl. D-rings on bottom for anchoring platform or connect to other inflatable products and brands

Scope of delivery:

- 1 x packing bag & 1 x manual
- 1 x repair kit without glue
- Pump & handle connector pro (21402) are not included

EVA TEAK DECK

The highlight is the pleasant EVA teak deck:

- very soft and comfortable top surface
- non-slip surface
- UV and salt water resistant
- Teak deck optic

FEATURE

Yachtbeach Fasten Tube for Boarding Ladder



ON PLATFORMS:

2.05 (22403), 3.08 (23229), 4.10 (22402), PAV. HEX 4.10 (23253), PAV. SQUARE 3.08 (25149), PAV. SQUARE 4.10 (25164)

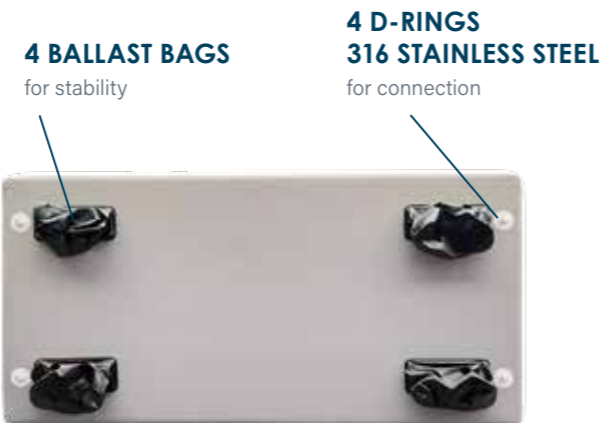
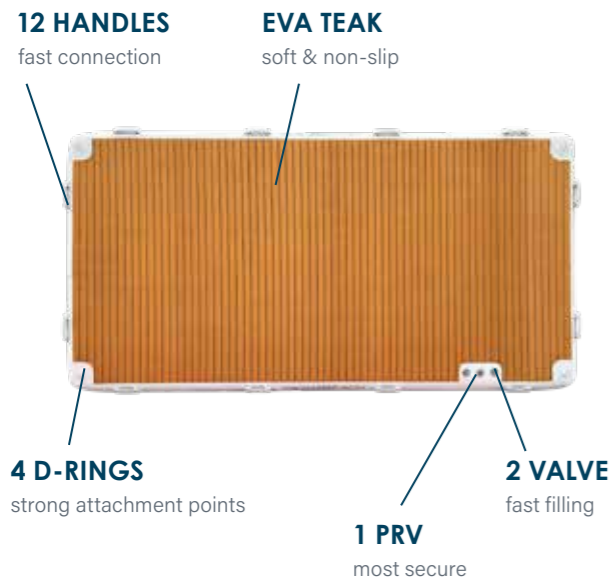

PLATFORM 2.05 PREMIUM TEAK

Measurements:
Size: 205x205cm - 6,7'x6,7'
Weight incl. bag: approx. 22,3 kg - 49lbs
Packing size: approx. 220x35x28cm - 86"x14"x11,3"

CODE 22403
Price \$ 2.799,00



PLATFORM 3.08 PREMIUM TEAK

Measurements:
Size: 308x155cm - 10,1'x5'
Weight incl. bag: approx. 25 kg - 55,11lbs
Packing size: approx. 166x38x26cm - 65"x15"x10"

CODE 23229
Price \$ 2.799,00



PLATFORM 4.10 PREMIUM TEAK

Measurements:
Size: 410x205cm - 13'x6,7'
Weight incl. bag: approx. 41,2 kg - 90lbs
Packing size: approx. 218x36x31cm - 86"x14"x12"

CODE 22402
Price \$ 3.599,00



NEW PLATFORM 6.16 PREMIUM TEAK

Measurements:
Size: 616x205cm - 20'x6,7'
Weight incl. bag: approx. 61 kg - 130lbs
Packing size: approx. 218x45x36cm - 86"x17"x14"

CODE 24279
Price \$ 5.499,00



NEW PLATFORM 8.20 PREMIUM TEAK

Measurements:
Size: 820x205cm - 26,9'x6,7'
Weight incl. bag: approx. 78 kg x 172lbs
Packing size: approx. 218x48x48cm - 86"x18,9"x18,9"

CODE 24280
Price \$ 6.999,00

NEW

YACHTBEACH MULTI STATION

Measurements:

External dimensions: 102x108cm - 3,3'x3,5'
Internal width: 62cm - 2'
Tube diameter: 20cm - 7,9"
Suitable for Toys: approx. 60 cm - 79,5 cm (23,6' - 31,3')

Characteristics:

- > Designed as the simplest dock solution for water toys such as Seabob, E-Boards, Jetboards and E-Foil Boards
- > Comes with 2 securing straps for safe attachment of your toy
- > Compatible with various connection systems for Yachtbeach and other inflatable docks
- > Compact and lightweight design for easy handling and storage

Scope of delivery:

Note: no carry bag and repair kit without glue, pump & handle connector (21402) included

DIFFERENT SETUP OPTIONS:

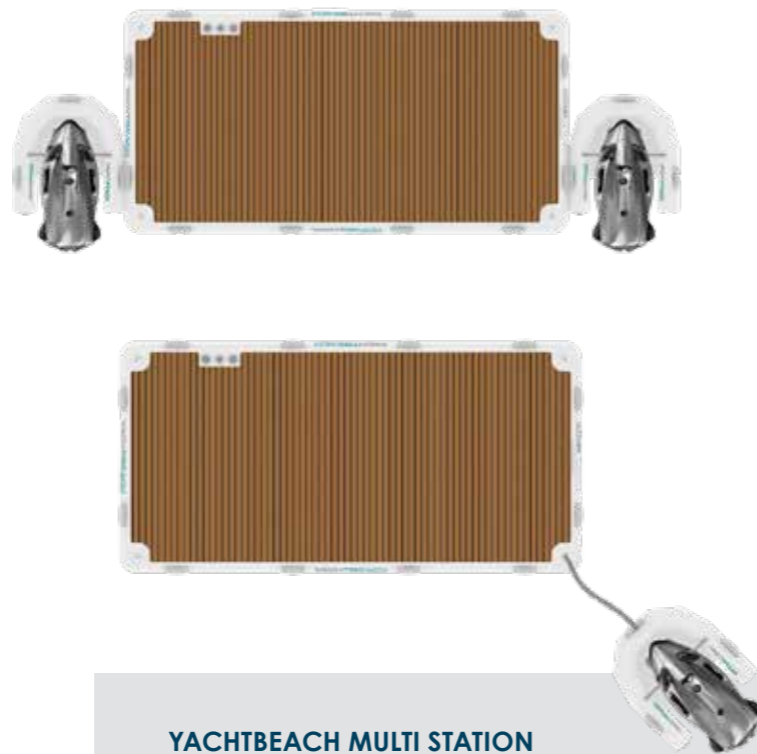
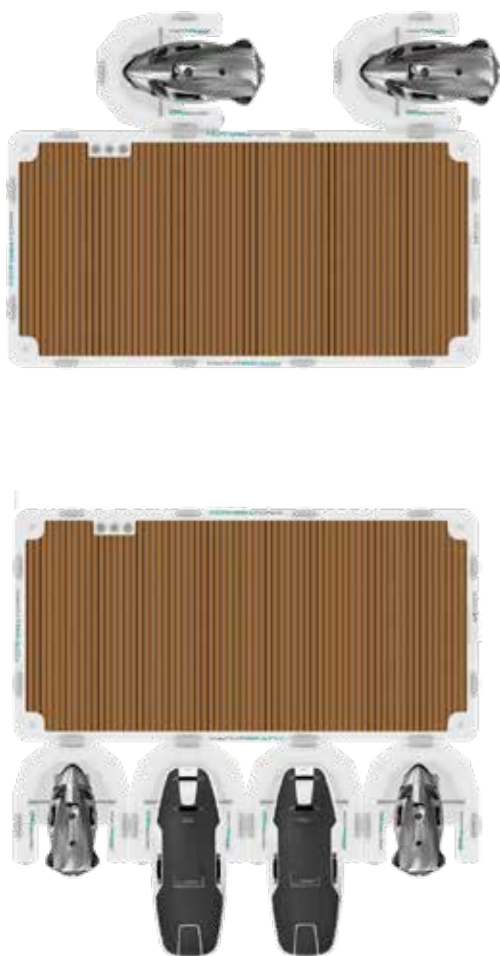

YACHTBEACH MULTI STATION CODE 26145

ONE UNIT
Price \$ 789,00

YACHTBEACH MULTI STATION DOUBLE PACK CODE 26146

PACKAGE OF TWO UNITS
Price \$ 1.499,00

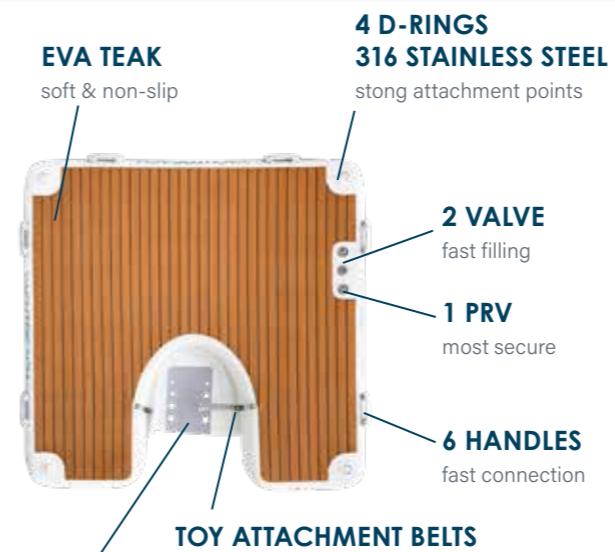

PARK YOUR WATERTOY HERE



YACHTBEACH MULTI DOCK SINGLE 2.05

Measurements:

Size: 205x205cm - 6,7'x6,7'
Weight incl. bag: approx. 21,9 kg - 48,28lbs
Packing size: approx. 220x35x28cm - 87"x14"x11,3"

Material:

Dropstitch with 20cm thickness - provides incredible stability and even more safety.

Foam Surface/Foam Top:

made of flexible EVA teak, UV and saltwater resistant

Characteristics:

- > 6 Handles: Handle Connection System provides compatibility to all Yachtbeach platforms and Luxury Pools, as well as for other commercially available platforms.
- > Valve: equipped with 2 high pressure valves which allow quick and easy filling and draining. The high quality pressure relief valve ensures the correct pressure even in sunny conditions. 2 valves bring a time save of 50% when inflating or deflating
- > Incl. 4-Drings on top for numerous connection options from above surface
- > Incl. 2-Drings on bottom for anchoring platform or connect to other inflatable products and brands
- > 2 ballast bags
- > Matching for Seabob or similar power toys.

Scope of delivery:

1x carrying bag
1x repair kit without glue.
Pump & handle connector pro (21402) are not included

YACHTBEACH MULTI DOCK SINGLE 2.05 CODE 22401

Price \$ 2.999,00

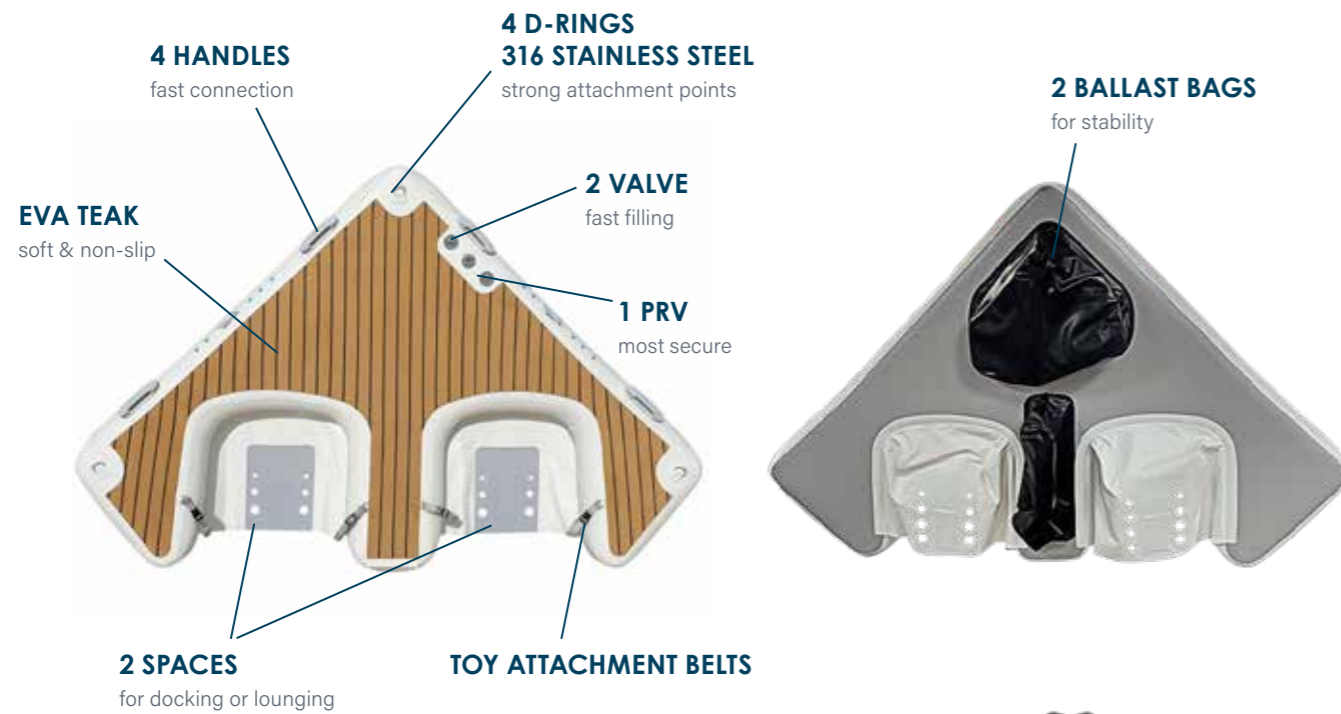
**YACHTBEACH MULTI DOCK & LOUNGER DOUBLE 2.05**

Multi Dock and Lounger in one product. Suitable for easy parking of up to 2 Seabobs or IAqua, Jetsurf Boards, Radinn Boards, Magicsurf Boards, Onean Boards, esurf Boards, Awake or Lampuga Boards. In addition to parking, it also offers a super comfortable lounge function for 2 people. It can also be used and attached in the luxury pool.

It is noteworthy that the Yachtbeach Multi Dock and Lounger can be easily combined and varied with all Yachtbeach platforms and luxury pools using the handle connection system. Beautiful, pleasant, non-slip and hardwearing foam surface made of EVA in teak look.

Measurements:

Size: 205x205cm - 6,7'x6,7'

Weight: approx. 17,8 kg - 39,24lbs

Pack size: approx. 180x33x20cm - 71"x13"x8"

Material:

Dropstitch with 20cm thickness - offers incredible stability and even more safety

Foam Top:

made of flexible EVA Teak, UV and salt water resistant.

Characteristics:

- > 4 handles: Handle Connection System offers compatibility with all Yachtbeach platforms and luxury pools, as well as for other common platforms
- > Valve: equipped with 2 high pressure valves which allow quick and easy filling and emptying. The high-quality pressure relief valve ensures the right pressure even in sunshine. 2 valves save 50% of the time when filling or emptying.
- > D-rings: 3 D-rings for numerous fastening options
- > 2 ballast bags

Scope of delivery:

1x carrying bag

1x repair kit without glue

Pump & handle connector pro (21402) are not included



**YACHTBEACH MULTI DOCK & LOUNGER
DOUBLE 2.05
CODE 20397**

Price \$ 3.199,00

**YACHTBEACH SPARE STRAPS FOR MULTI DOCK
CODE 24371**

Price \$ 19,00

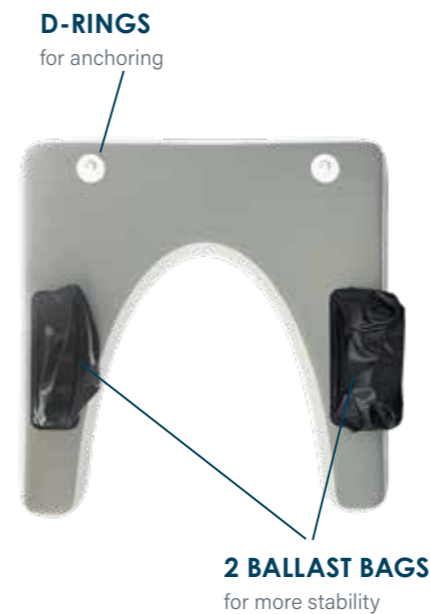
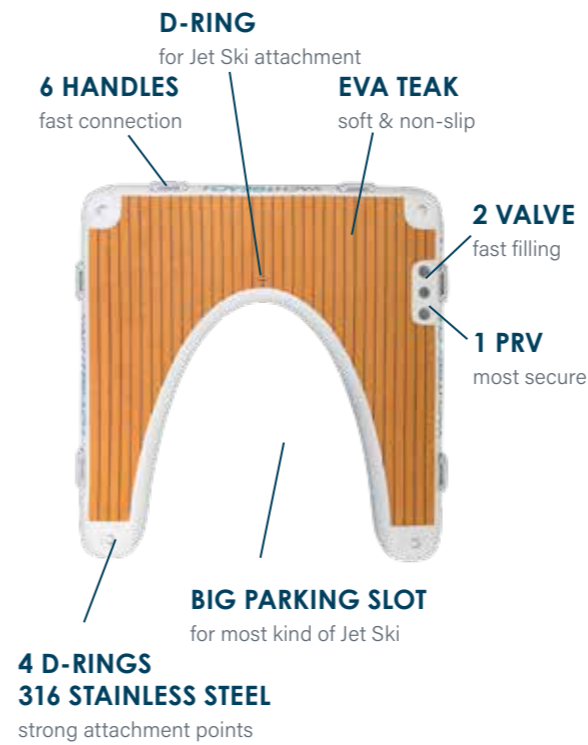

YACHTBEACH JET SKI DOCK SINGLE 2.05

Measurements:

Size: 205x205cm - 6,7'x6,7'

Weight incl. bag: approx. 16,9 kg - 37,2lbs

Packing size: approx. 210x35x28cm - 83"x14"x11"

Material:

Dropstitch with 20cm thickness - provides incredible stability and even more safety.

Foam Surface/Foam Top:

made of flexible EVA teak, UV and saltwater resistant

Characteristics:

- > 6 handles: Handle Connection System provides compatibility to all Yachtbeach platforms and Luxury Pools, as well as for other commercially available platforms.
- > Valve: equipped with 2 high pressure valves which allow quick and easy filling and emptying. The high-quality pressure relief valve ensures the right pressure even in sunshine.
- > Incl. 4-Drings on top for numerous connection options from above surface
- > Incl. 2-Drings on bottom for anchoring platform or connect to other inflatable Products and Brands
- > 2 ballast bags

Matching for most kind of Jet Ski's on the Market.

Scope of delivery:

1x carrying bag

1x repair kit without glue

Pump & handle connector pro (21402) are not included

**YACHTBEACH JET SKI DOCK SINGLE 2.05
CODE 22400**

Price \$ 2.999,00



**PROTECTED BY
INTERNATIONAL PATENT**

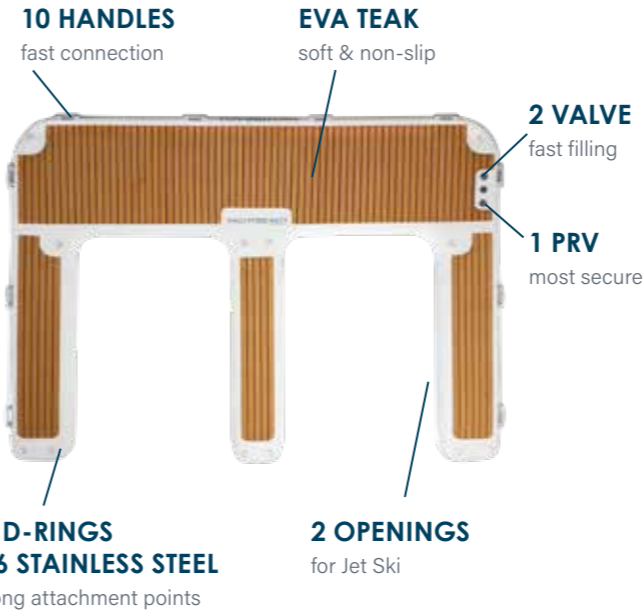

YACHTBEACH JET SKI DOCK DOUBLE 4.10

The Jet Ski Dock has longer divided arms that the jet skis can not collide and be better protected. The divided arms are each 200cm long and 55cm wide - the middle department arm has a width of 40cm.

Measurement:
External dimensions: 410cm x 300cm - 13,5'x10'
Weight incl. bag: approx. 37,5kg - 82,67 lbs
Pack size: approx. 220x35x30cm - 87"x14"x11,8"

Material:
Material thickness: 20cm strengthened drop stitch
Valve: 2-chamber safety system

Foam Top:
made of hardened EVA

- Characteristics:**
- > D-rings:
 - 4 D-rings at the bottom
 - 12 D-rings at the top for numerous mounting options
 - > Handles: 10 high-quality fastening and carrying handles
 - > 3 ballast bags for more stability

Scope of delivery:
1x carrying bag
1x Repair set without glue
Pump & handle connector pro (21402) are not included

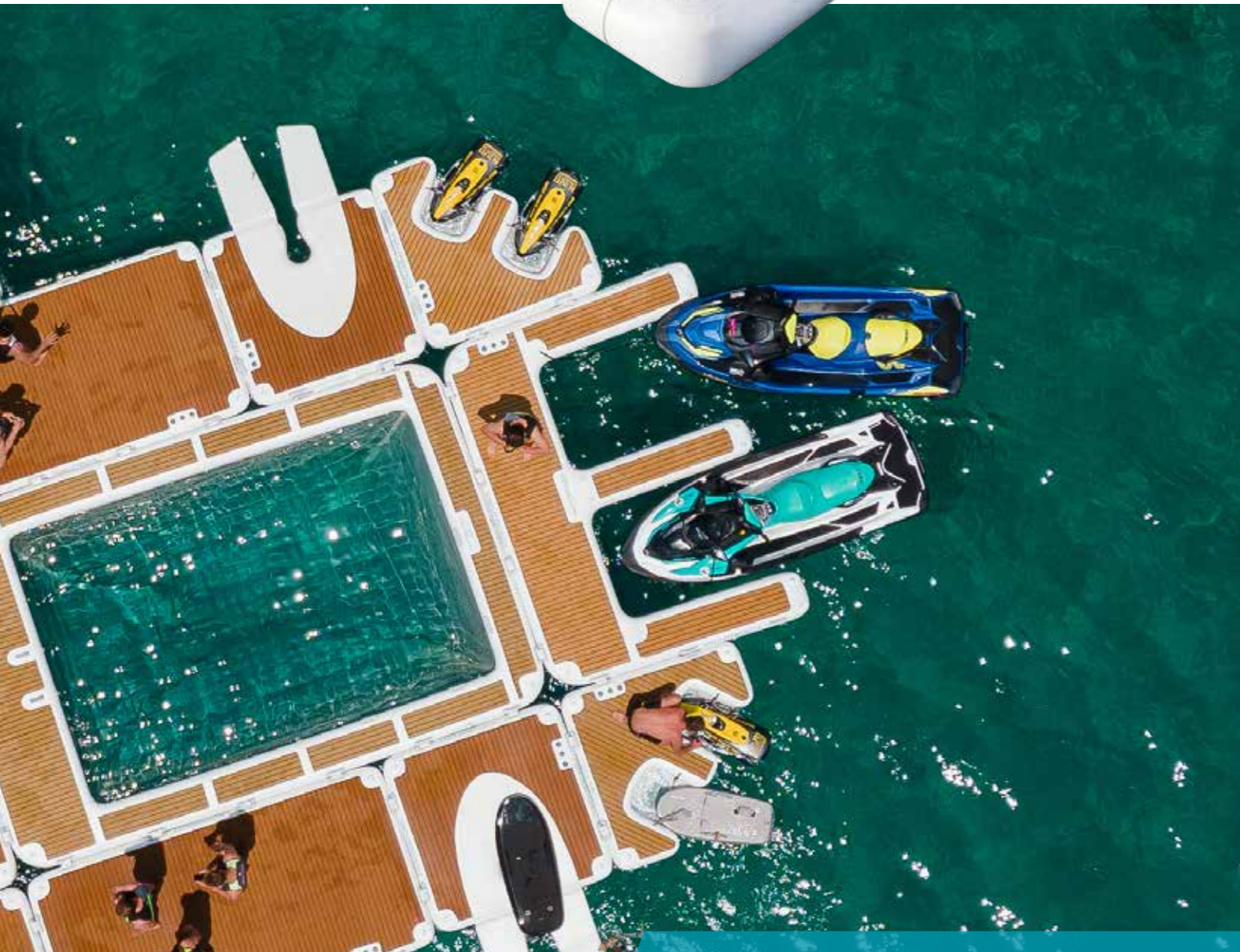

YACHTBEACH JET SKI DOCK DOUBLE 4.10
CODE 19743

Price \$ 5.499,00



**PROTECTED BY
INTERNATIONAL PATENT**



YACHTBEACH FOIL DOCK SINGLE 2.05

Measurements:

Size: 205x205cm - 6,7'x6,7'

Weight incl. bag: approx. 26,8 kg - 59lbs

Packing size: approx. 220x35x28cm - 87"x14"x11"

Material:

Dropstitch with 20cm thickness - provides incredible stability and even more safety.

Foam Surface/Foam Top:

made of flexible EVA teak, UV and saltwater resistant

Ramps:

covered with Slip PVC Material

Characteristics:

- > 2 Ramps with 8 cm thickness
- > 6 handles: Handle Connection System offers compatibility with all Yachtbeach platforms and luxury pools, as well as for other common platforms
- > Valve: equipped with 4 high pressure valves which allow quick and easy filling and emptying. The high-quality pressure relief valve ensures the right pressure even in sunshine.
- > Incl. 4-Drings on top for numerous connection options from above surface
- > Incl. 2-Drings on bottom for anchoring platform or connect to other inflatable Products and Brands
- > 4 ballast bags
- > 12 metal-free YACHTBEACH handles

Scope of delivery:

- 1x carrying bag
- 1x repair kit without glue
- Pump & handle connector pro (21402) are not included

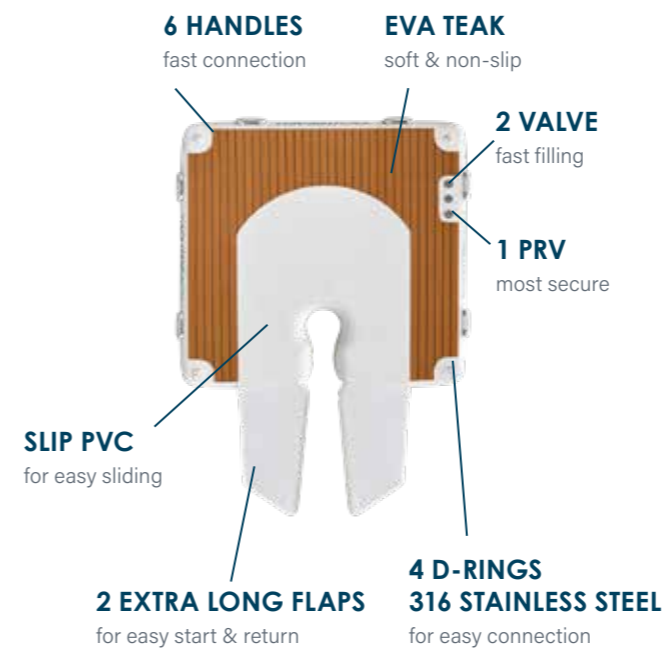

**4 D-RINGS
316 STAINLESS STEEL**
for easy connection



**YACHTBEACH FOIL DOCK SINGLE 2.05
CODE 22421**

Price \$ 3.499,00

**YACHTBEACH SPARE STRAPS
FOR FOIL DOCK/FOIL RAMP - 140 CM
CODE 25217**

Price \$ 19,00



**YACHTBEACH FOIL RAMP**

This is the perfect extension to floating Platforms and create a dock for any Foil board on the market. The Foil Ramp can be inflated within seconds and is super easy to be attached to Yachtbeach Platforms, Pools or Docks with just 2 of the Yachtbeach Handles Connectors. The Yachtbeach super slippery top Surface enables going in and out with the Foil Board without any challenge. Be surprised how easy you can now dock and restart your Foil and most important keep damages from the yacht away.

Protected by International Patent

Measurements:

Main Platform: 148 cm width, 185 cm length (into the water)

5 cm HDDS Top, 20 cm Tube

Weight incl. bag: approx. 13 kg - 28,66lbs

Packing size: approx. 75x51x29cm - 30"x20"x12"

Material:

Dropstitch with 20cm thickness - provides incredible stability and even more safety.

Foam Surface/Foam Top:

made of flexible EVA teak, UV and saltwater resistant

Ramps:

covered with Slip PVC Material

Characteristics:

- > 2 Yachtbeach Handles
- > 2 Valves
- > 1 Rubber Fender Line to protect Foil and product

Scope of delivery:

1 x basic carry bag

1 x repair kit without glue

Pump & Handle Connectors (21402) are not included



**VARIATION:
TWO RAMPS ON ONE 4.10 PLATFORM**



**YACHTBEACH FOIL RAMP
CODE 24284**

Price \$ 1.699,00





YACHTBEACH CLASSIC POOL 4.10

Measurements:

External dimensions: 410x410cm - 13,5'x13,5'

Depth: 220cm - 7'

Weight approx.: 45kg - 99lbs

Tube diameter: 25cm - 10"

Pack Size: 120x73x31cm - 47"x28,7"x12,2"

Handles:

- > 16 high quality mounting and carrying handles which are easy to combine with all Yachtbeach bathing platforms
- > 8 handles to get easily back in to the Ocean Pool

Scope of delivery:

Bathing ladder with carabiner

1x carry bag

1x repair kit without glue

Pump & handle connector pro (21402) are not included

SCAN ME

for a video



YACHTBEACH CLASSIC POOL 4.10
CODE 19740

Price \$ 2.999,00



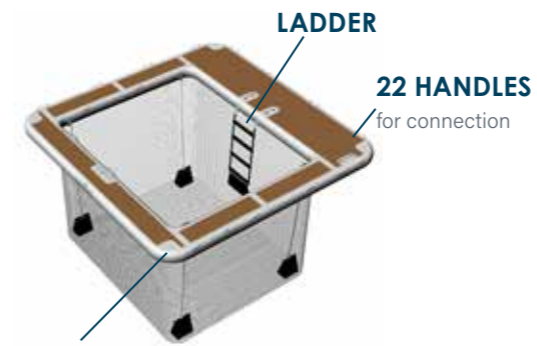

LADDER

22 HANDLES
for connection

4 D-RINGS
316 STAINLESS STEEL
easy connection

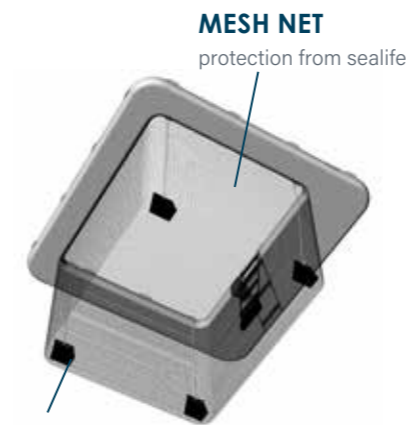

MESH NET

protection from sealife

BALLAST BAGS
for holding the net down

YACHTBEACH LUXURY POOL 4.10

Measurements:
External dimensions: 410x410cm - 13,5'x13,5'
Depth: about 220cm - 7,2'
Interior dimensions: 310x260cm (fine-mesh protective net)
Lying surface: width of 100cm, Side: width of 50cm
Weight incl. bag: approx. 66kg - 145,5lbs
Packing Size: approx. 185x63,9x43,8cm - 73"x25"x17"

Material Thickness:
Reinforced Drop Stitch with 20cm thickness

Foam top:
covered with flexible artificial teak

- Characteristics:
- > Valve: 2-chamber safety system
 - > Handles: 22 high-quality mounting and carrying handles
4 additional carrying handles are attached to the teak surface.
 - > D rings: 4 D-rings on the top and on the bottom
6 D-rings on the inside of the pool

Scope of delivery
1x carrying bag
1x repair set without glue
Pump & handle connector pro (21402) are not included

YACHTBEACH LUXURY POOL 4.10
CODE 20394

Price \$ 7.599,00



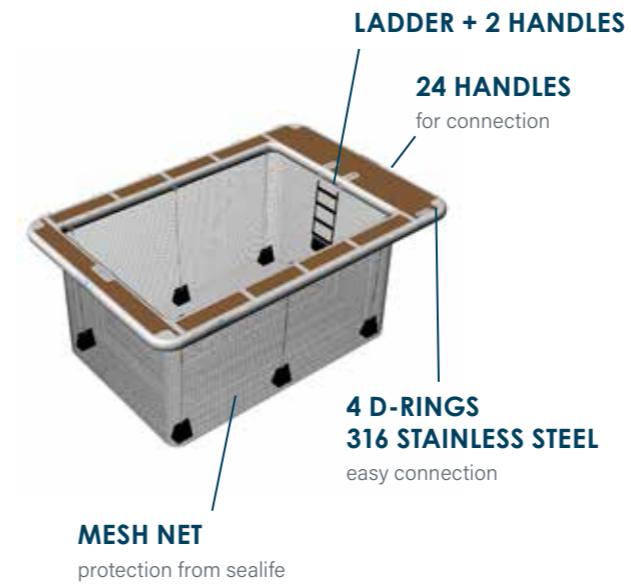

YACHTBEACH LUXURY POOL 6.20

Measurements:
 External dimensions: 616x410cm - 20'x13,5'
 Interior dimensions: 466x310cm made with a fine-mesh protective net
 Depth: 240cm - 7,8'
 Lying surface: width of 100cm
 Side surfaces: width of 50cm
 Weight: approx. 83 kg - 182,98lbs
 Packing size: 184x70x50cm - 72"x28"x20"

Material thickness:
 reinforced drop stitch with a thickness of 20cm
 It offers you incredible stability and is extremely safe, even when there are several people on the Yachtbeach Luxury Pool.

Foam top:
 made of flexible EVA teak

- Characteristics:**
- > Valve: equipped with 2 high pressure valves which allows a quick and easy filling. The high-quality pressure relief valve always ensures the right pressure at the pool. Thanks to the 2 valves, they save 50% of time when filling & emptying.
 - > Handles: 20 high-quality fastening, carrying and handholds
 - > D rings:
 - 4 D-rings on the top and bottom
 - 6 D-rings on the inside of the pool

Scope of delivery:
 1x carrying bag
 1x repair set without glue
 Pump & handle connector pro (21402) are not included

YACHTBEACH LUXURY POOL 6.20
CODE 19744

Price \$ 9.499,00

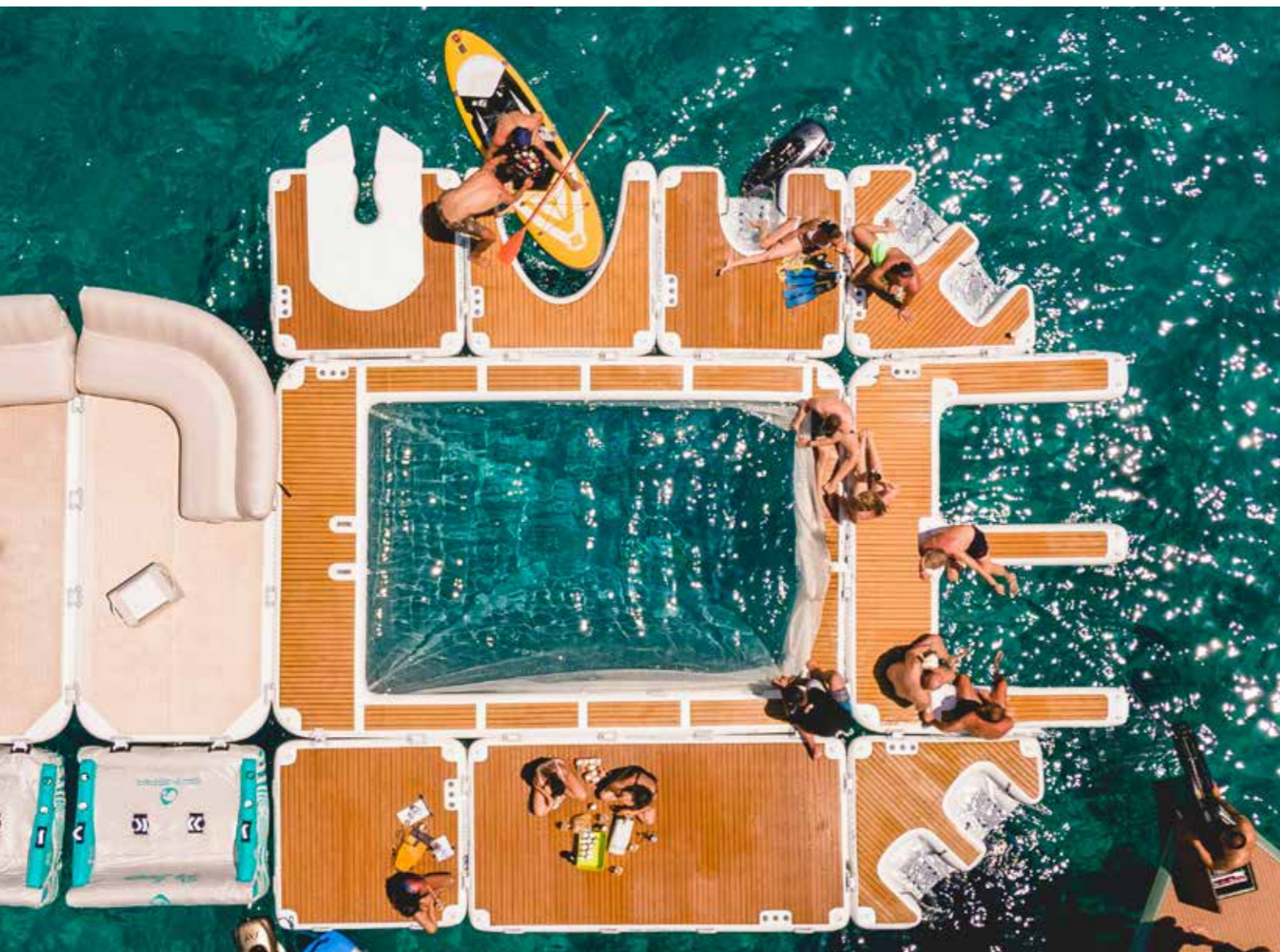

SUPERIOR POOL 6.16 & TOY DOCK 6.16

YACHTBEACH SUPERIOR POOL 6.16

Measurements:

External dimensions: 616x616cm - 242"x242"
 Main Pool: 468 x 468 cm, made with a fine-mesh protective net
 Splash Pool: 190 cm Diameter, covered with a removeable Mesh floor
 Mainwalk surface: 2 x 618 x 100cm
 Sidewalk surfaces: 2 x 618 x 50cm
 Depth: 240cm - 7,8'
 Weight incl. bag: 142kg - 313lbs
 Packing Size: 220x80x60 - 86"x31"x23"

Material thickness:

- > reinforced drop stitch with a thickness of 20cm
- > It offers you incredible stability and is extremely safe, even when there are several people on the Yachtbeach Superior Pool

Foam top:

made of flexible EVA teak

Characteristics:

- > Valve: equipped with 2 high pressure valves which allows a quick and easy filling. The high-quality pressure relief valve always ensures the right pressure at the pool. Thanks to the 2 valves, they save 50% of time when filling & emptying.
- > Handles: 24 high-quality fastening, carrying and handholds
- D rings:
 - > 4 D-rings on the top and bottom
 - > 6 D-rings on the inside of the pool incl. weight pockets
 - > 4 D-rings on bottom for anchoring

Scope of delivery:

- 1x carrying bag
- 1x repair set without glue
- Pump & handle connector pro (21402) are not included

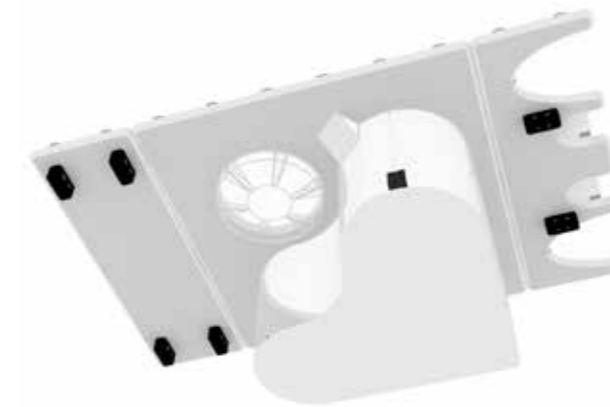
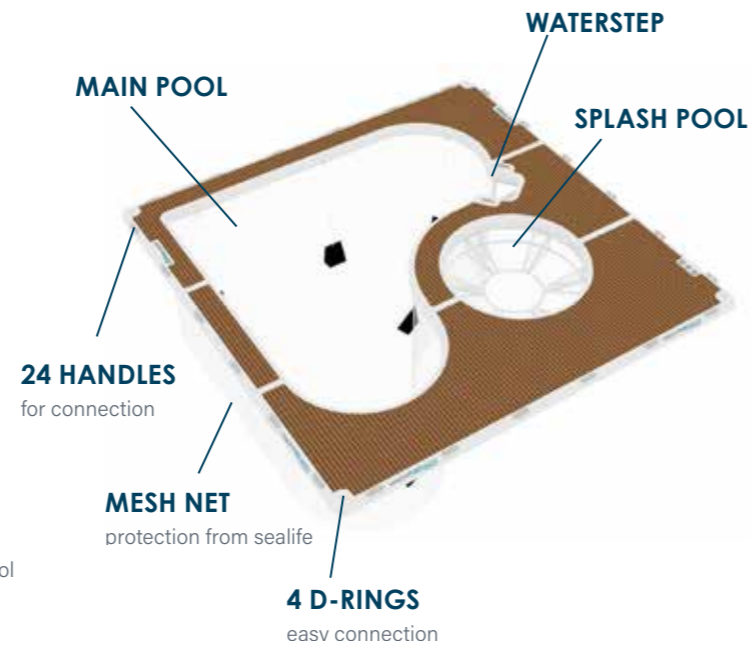

YACHTBEACH TOY DOCK 6.16

Measurements:

External dimensions: 616x205cm - 242"x80"
 Weight incl. bag: 49kg - 108lbs
 Pack size: 220x45x35cm - 86"x17"x13"

Material thickness:

reinforced drop stitch with a thickness of 20cm

Foam top:

made of flexible EVA teak

Characteristics:

- > Jet Ski Dock: 2 universal fit Jet Ski dockings
- > Seabob Dock: 2 dockings for Seabob
- > Yachtbeach Bathing Ladder Fastener (Ladder not included)
- > Valve: equipped with 2 high pressure valves which allows a quick and easy filling. The high-quality pressure relief valve always ensures the right pressure at the pool. Thanks to the 2 valves, they save 50% of time when filling & emptying.

Handles:

- > 10 high-quality fastening, carrying and handholds
- D rings:
 - > 4 D-rings on the top
 - > 4 D-rings on bottom for anchoring
- > Ballast: 2 Ballast Bags for best balance and stability

Scope of delivery:

- 1x carrying bag
- 1x repair set without glue
- Pump & handle connector pro (21402) are not included

PLATFORM 6.16

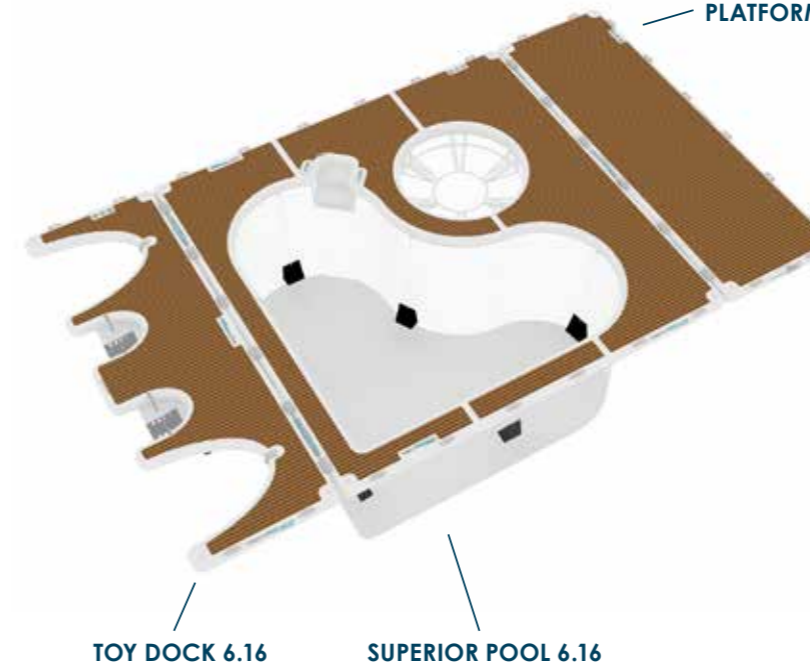

YACHTBEACH SUPERIOR POOL 6.16 CODE 24282

Price \$ 14.999,00

YACHTBEACH TOY DOCK 6.16 CODE 24285

Price \$ 6.199,00

YACHTBEACH PLATFORM 6.16 CODE 24279

Price \$ 5.499,00



YACHTBEACH SUPERIOR POOL 8.20

Measurements:

External dimensions: 820x618cm - 27'x20'
 Main Pool: 650 x 448 cm, made with a fine-mesh protective net
 Splash Pool: 190 cm Diameter, covered with a removeable Mesh floor
 Mainwalk surface: 820 x 100cm + 618 x 100 cm
 Sidewalk surfaces: 820 x 70 cm + 618 x 70 cm
 Depth: 240cm - 7,8'
 Weigh incl. bag: 184kg - 185lbs
 Pack size: 220x80x70 - 86"x31"x27"

Material thickness:

reinforced drop stitch with a thickness of 20cm
 It offers you incredible stability and is extremely safe, even when there are several people on the Yachtbeach Superior Pool

Foam top:

made of flexible EVA teak

Characteristics:

- > Valve: equipped with 2 high pressure valves which allows a quick and easy filling. The high-quality pressure relief valve always ensures the right pressure at the pool. Thanks to the 2 valves, they save 50% of time when filling & emptying.
 - > Handles: 28 high-quality fastening, carrying and handholds
- D rings:
- > 4 D-rings on the top and bottom
 - > 6 D-rings on the inside of the pool incl. weight pockets
 - > 4 D-rings on bottom for anchoring

Scope of delivery:

- 1x carrying bag
- 1x repair set without glue
- Pump & handle connector pro (21402) are not included

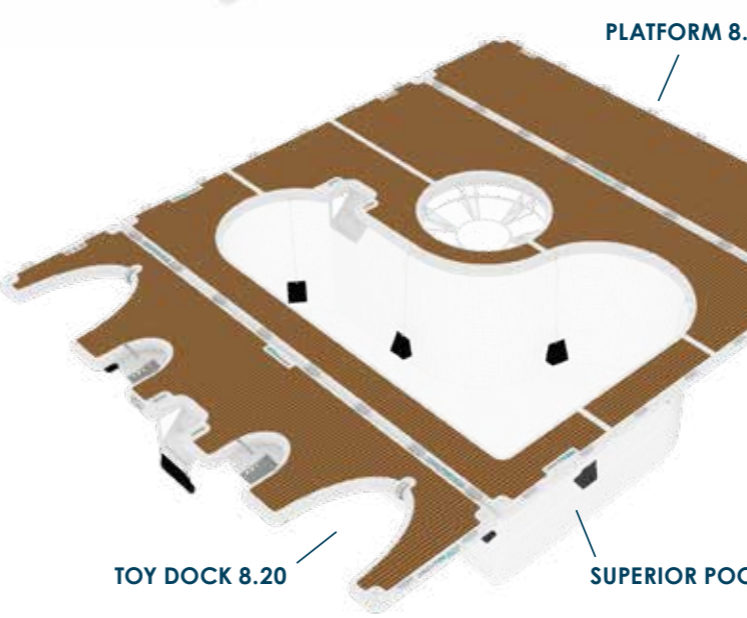
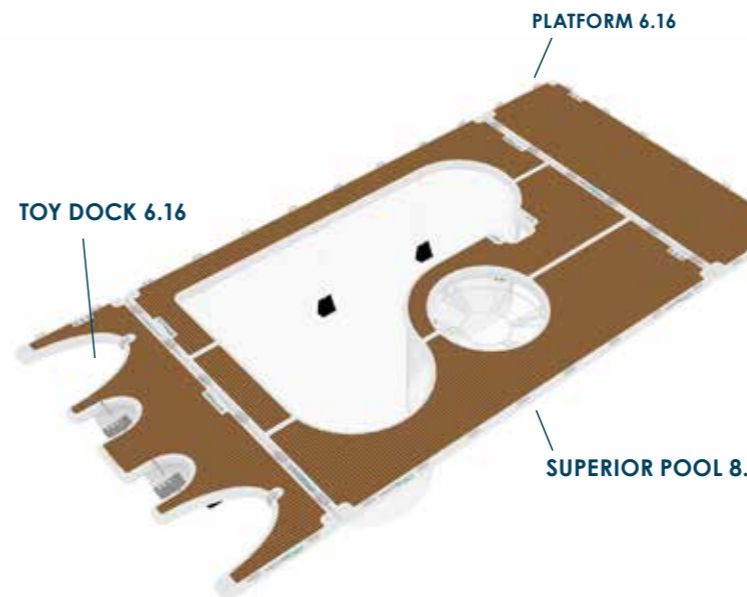

YACHTBEACH TOY DOCK 8.20

Measurements:

External dimensions: 820x205cm - 27'x6,7'
 Weight incl. bag: 66kg - 145lbs
 Packing size: 220x50x43cm - 86"x19"x17"

Material thickness:

reinforced drop stitch with a thickness of 20cm

Foam top:

made of flexible EVA teak

Characteristics:

- > Jet Ski Dock: 2 universal fit Jet Ski dockings
 - > Seabob Dock: 2 dockings for Seabob
 - > Water Steps: easy exit water steps with double handle
 - > Valve: equipped with 2 high pressure valves which allows a quick and easy filling. The high-quality pressure relief valve always ensures the right pressure at the pool. Thanks to the 2 valves, they save 50% of time when filling & emptying.
 - Handles: 12 high-quality fastening, carrying and handholds
- D rings:
- > 4 D-rings on the top
 - > 4 D-rings on bottom for anchoring
 - > Ballast: 2 Ballast Bags for best balance and stability

Scope of delivery:

- 1x carrying bag
- 1x repair set without glue
- Pump & handle connector pro (21402) are not included

YACHTBEACH Superior Pool 8.20
 Code 24283
 Price \$ 19.999,00

YACHTBEACH Toy Dock 8.20
 Code 24286
 Price \$ 8.499,00

YACHTBEACH Platform 8.20
 Code 24280
 Price \$ 6.999,00

YACHTBEACH Toy Dock 6.16
 Code 24285
 Price \$ 6.199,00

YACHTBEACH Platform 6.16
 Code 24279
 Price \$ 5.499,00



GO HONEYCOMB WITH YOUR WATER SETUP!

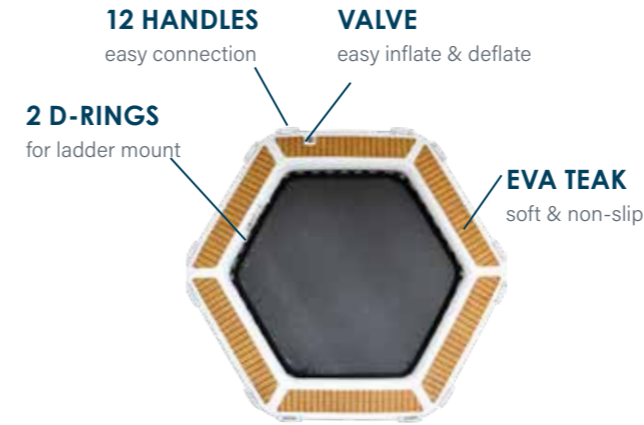
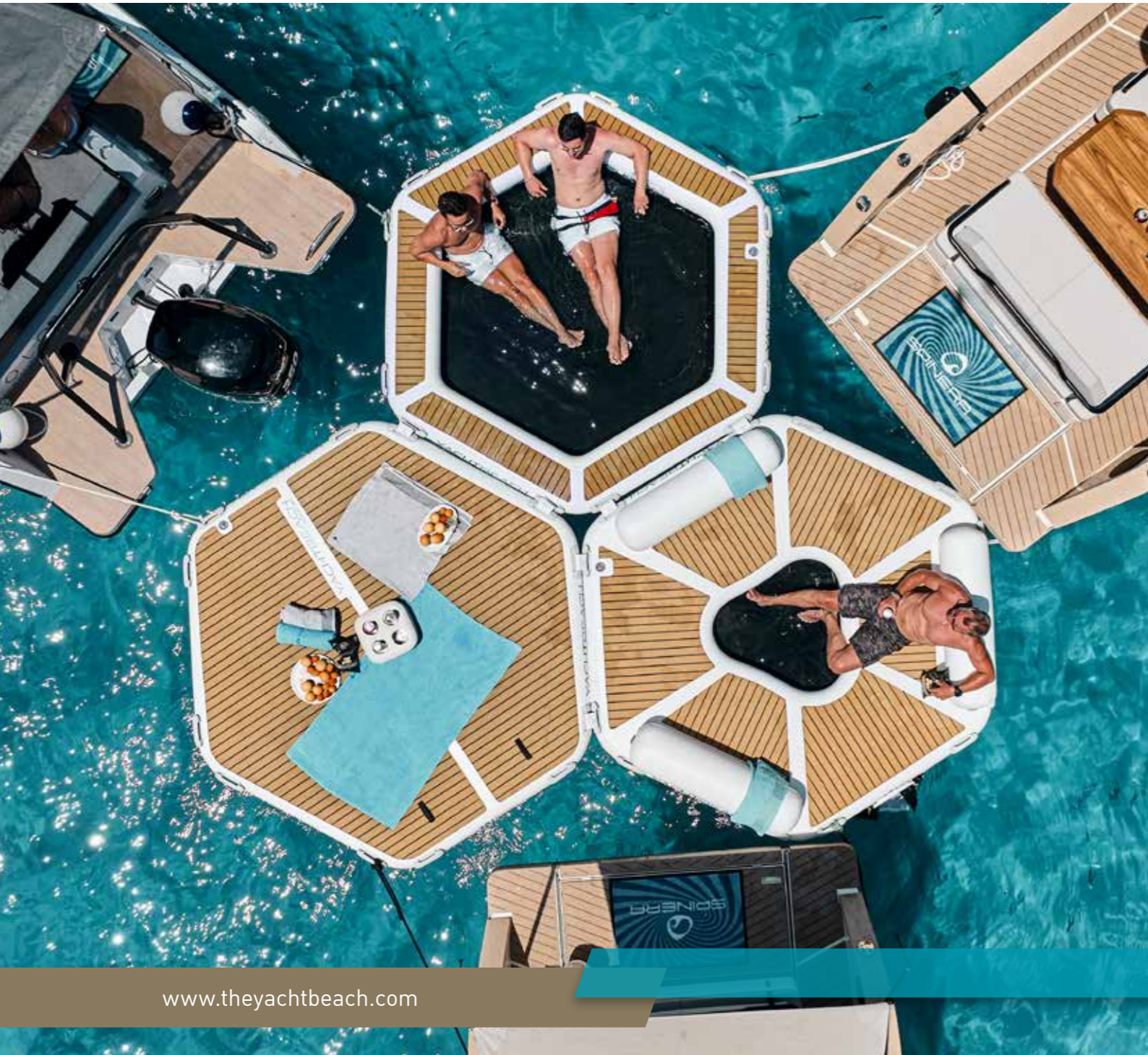

YACHTBEACH PARTY ZONE 2.50

This is your perfect chillout and party area behind the yacht. Here you can hang out all day and unwind or have a cool party. The mesh sits on top of the watersurface so your guest will always stay cool! With drink holders for 6 people, nothing stands in the way of your party. As a stand-alone platform behind the yacht or to extend your island. There are no limits to your imagination.

Measurements:

External dimensions: 250x290cm - 8,2'x9,5'
Height Dropstitch: 20cm - 7,8"
Weight incl. bag: approx. 14,5 kg - 31,96lbs
Packing size: 133x50x21cm - 52"x20"x8"

Material thickness:

Dropstitch with 20cm thickness - provides incredible stability and buoyancy.

Foam top:

made of flexible EVA teak, UV and saltwater resistant.

Characteristics:

- > 6 sides hexagon design for ideal arrangement of 6 or more adults
- > 12 Yachtbeach connector handles
- > floating mesh floor - exchangeable or removeable
- > 2 D-rings on bottom for anchoring or connection to other inflatable structures
- > 2 D-rings for ladder (23211)

Scope of delivery:

- 1x carrying bag
- 1x repair set without glue
- 6x removable cup holder (24317)

Pump, ladder (23211) & handle connector pro (21402) are not included

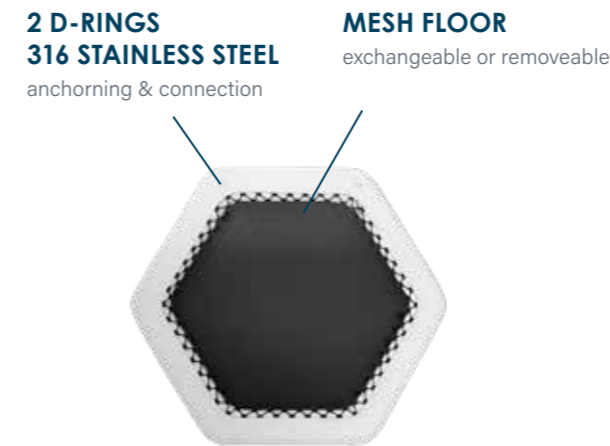

YACHTBEACH PARTY ZONE 2.50 CODE 23163

Price \$ 1.399,00

ACCESSORIES: POOL MESH FOR PARTY ZONE INCL. LADDER CODE 23212

Price \$ 399,00

Use Party Zone as a pool as well!

220CM MESH

To convert party zone to a party pool and stay safe from jelly fish!



YACHTBEACH SPORT ZONE 2.50

The "Sport Zone 2.50" can be used in many ways. Use it as extra yacht space, as a yoga platform or a dock for your water toys or chill with your buddies in the evening. As a stand alone platform behind the yacht or to expand your island in combination with other Yachtbeach platforms.

Measurements:

External dimensions: 250x290cm - 8,2'x9,5'
Height Dropstitch: 20cm - 7,8"
Weight incl. bagt: approx. 26 kg - 58,75lbs
Packing size: 145x35x35cm - 57"x14"x14"

Material thickness:

Dropstitch with 20cm thickness - provides incredible stability and buoyancy.

Foam top:

made of flexible EVA teak, UV and saltwater resistant.

Characteristics:

- > 6 sides hexagon design for ideal arrangement of 6 or more adults
- > 12 Yachtbeach connector handles
- > 2 D-rings on bottom for anchoring or connection to other inflatable structures
- > 2 D-rings for ladder (23211)
- > 1 Ballast Bag for maximum stability on the water

Scope of delivery:

- 1x carrying bag
- 1x repair set without glue
- Pump, ladder (23211) & handle connector pro (21402) are not included

VALVE
easy inflate & deflate

12 HANDLES
easy connection

EVA TEAK
soft & non-slip

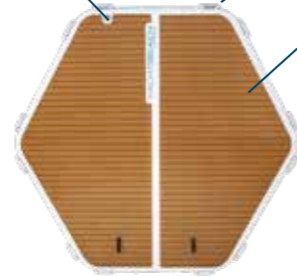

2 D-RINGS
316 STAINLESS STEEL
anchoring & connection



BALLAST BAG
for stability

2 D-RINGS
for ladder mount

YACHTBEACH SPORTS ZONE 2.50 CODE 23208

Price \$ 1.499,00



YACHTBEACH RELAX ZONE 2.50

The new hex platform Yachtbeach "Relax Zone 2.50" was created to relax by the sea and enjoy wonderful pool days behind your yacht. Sit stabil and dry on 20cm dropstitch floor with integrated soft teak EVA while your feet can touch water in the center. With drink holders for 6 people and 3 back backrest tubes, you can really hang out with your friends and family.

Measurements:

External dimensions: 250x290cm - 8,2'x9,5'
Height Dropstitch: 20cm - 7,8"
Weight incl. bag: approx. 29,95 kg - 66lbs
Packing size: 125x65x37cm - 49"x26"x15"

Material thickness:

Dropstitch with 20cm thickness - provides incredible stability and buoyancy.

Foam top:

made of flexible EVA teak, UV and saltwater resistant.

Characteristics:

- > 3 inflatable backrest tubes
- > 12 Yachtbeach connector handles
- > floating mesh floor - exchangeable or removeable
- > 2 D-rings on bottom for anchoring or connection to other inflatable structures
- > 2 D-rings for ladder (23211)

Scope of delivery:

- 1x carrying bag
- 1x repair set without glue
- 6x removable cup holder (24317)

Pump, ladder (23211) & handle connector pro (21402) are not included

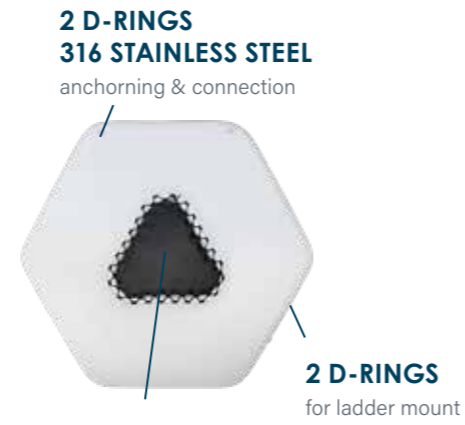
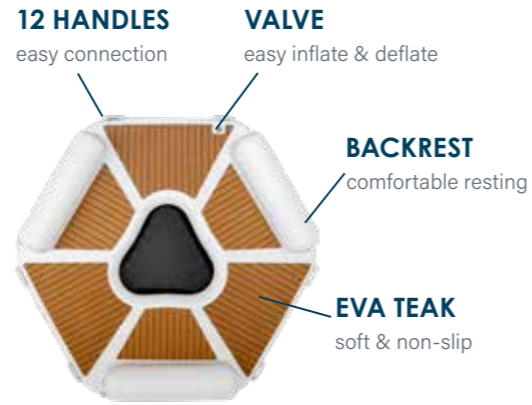

YACHTBEACH RELAX ZONE 2.50
CODE 23207
Price \$ 1.699,00



FITS FOR ALMOST ANY YACHTBEACH ITEM







CREATE YOUR PERFECT ARRANGEMENT FOR YOUR COMMERCIAL OR PRIVATE EVENT

GET IN TOUCH WITH OUR SALES TEAM!



VARIOUS
SETUP
POSSIBILITIES

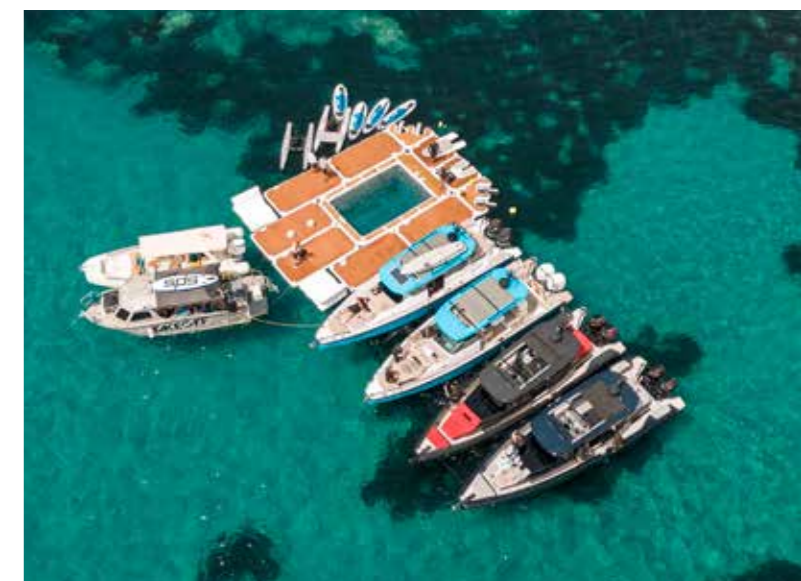
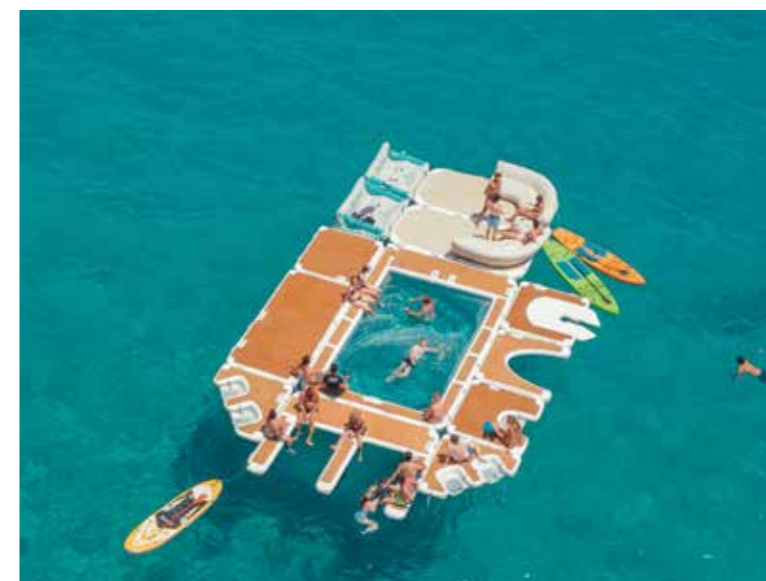





YACHTBEACH PAVILION BEACHCLUB SYSTEM

Measurements:

Pavilion Platform - 410 x 355cm

Pavilion Tent - 500 x 430 cm / 185cm open height

Capacity:

Up to 8 Person

The Pavilion redefines event architecture with its drop stitch inflatable structure, providing a stylish and weather-resistant space that seamlessly blends outdoor charm with indoor comfort. Feeling in connection with water and enjoying the comfort of The Pavilion gives more value to every set-up. It consists of different elements and is a modular system. We have the base platform with interchangeable floor options and a tent which offers you shade and also has different options for the top cover. When you struggle with low sun, there is also an add-on available, you can add curtain elements on the tent to have better shade in different situations. For maximum comfort we offer the Pavilion Sofa and the Backrest, as well as a table which fits perfectly in the middle. These elements can also be used separately on the beach as a comfortable lounge setup.



**PROTECTED BY
INTERNATIONAL PATENT**

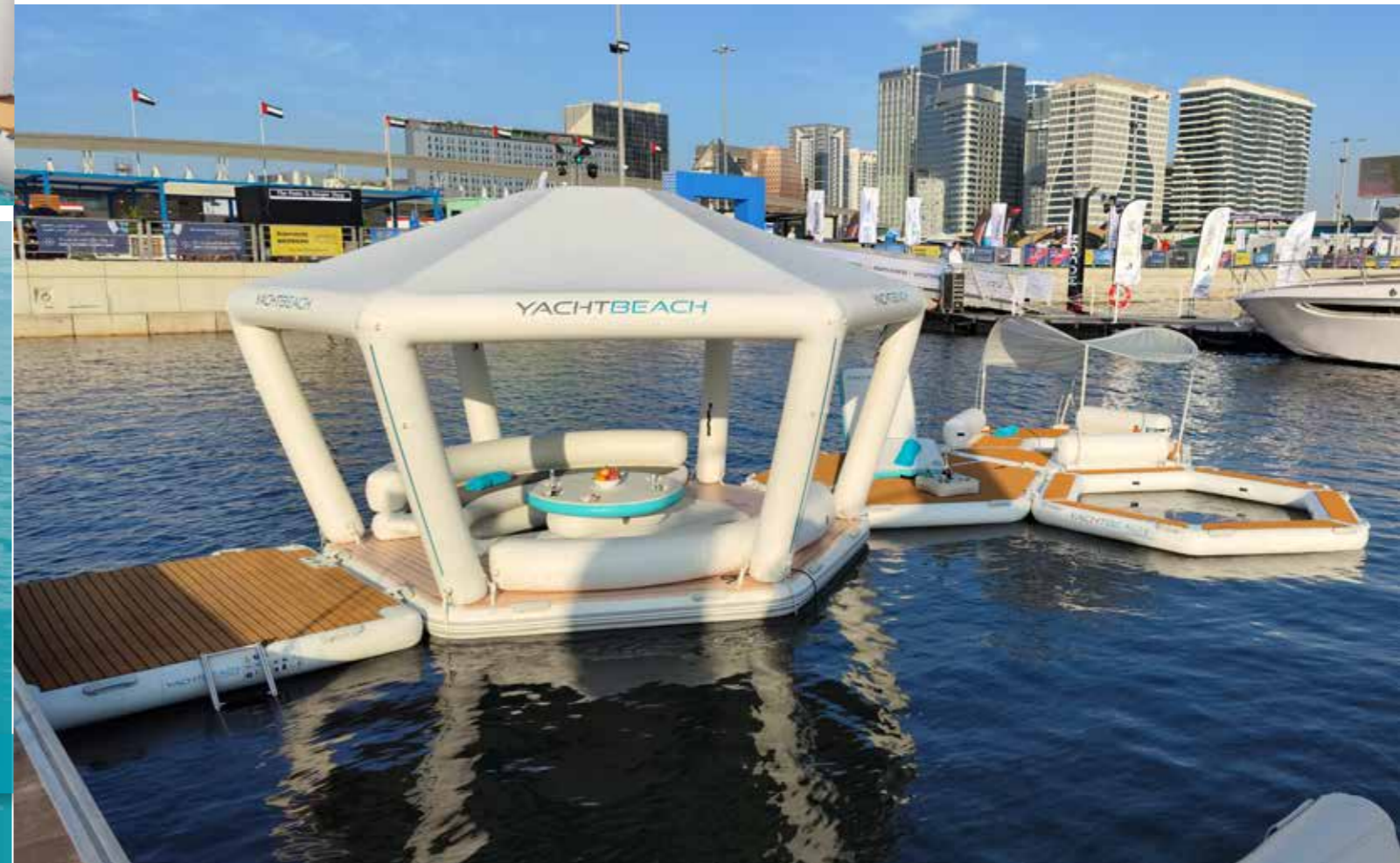

**YACHTBEACH HEX PLATFORM 4.10
WITH HOLE 170CM DIAMETER
CODE 25191**

Pack size: 102x68x42cm - 40"x27"x17"

Price \$ 3.999,00



RAIN COVER
optional

AIR VENT COVER
incl. with Tent 23234

CURTAIN
25152
incl. with Tent 23234

PAVILION TENT
23234
Price \$ 2.999,00

PAVILION SOFA
25185
Price \$ 949,00

PAVILION TABLE
25184
Price \$ 949,00

PAVILION BACKREST
25186
Price \$ 649,00

DEEP MESH
25194
enjoy your feet in
the water
Price \$ 399,00

FLAT MESH
25193
allows to sit &
loungue on the
water surface
incl. with
Platform 25191
Price \$ 219,00

FLAT COVER
25192
stay mostly dry
inside the pavilion
Price \$ 329,00



**HEX PAVILION
PARTY SETUP
CODE 24288**

Price \$ 4.599,00

- Platform
- Backrest
- Flat Mesh Cover



**HEX PAVILION
LOUNGE SETUP
CODE 24295**

Price \$ 6.499,00

- Platform
- Table
- Sofa
- Backrest
- Flat Mesh Cover



**HEX PAVILION
BEACHCLUB SETUP
CODE 24287**

Price \$ 9.499,00

- Platform
- Tent
- Table
- Sofa
- Backrest
- Flat Mesh Cover
- 6x curtains

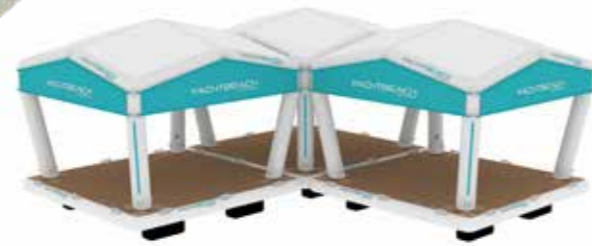

YACHTBEACH SQUARE PAVILION

Measurements:
Pavilion Platform - 308 x 308 cm
Pavilion Tent - 308 x 308 cm
Capacity:
Up to 6 Person

Measurements:
Pavilion Platform - 410 x 410 cm
Pavilion Tent - 410 x 410 cm
Capacity:
Up to 12 Person

The new Yachtbeach Square Pavilion is an inflatable modular system with platform, tent and curtains. The Yachtbeach Pavilion offers a stylish and weatherproof space that seamlessly combines the charm of the outdoors with the comfort of the indoors. The tent with 4 pillars allowing for optional curtains to be hung.

YACHTBEACH SPORT PLATFORM 3.08x3.08 GRIP TEAK CODE 25149

Pack size: 96x62x48cm - 38"x24"x19"

Price \$ 3.599,00

YACHTBEACH PAVILION TENT 3.08x3.08 CODE 25148

Pack size: 90x64x38cm - 35"x25"x15"

Price \$ 2.599,00

YACHTBEACH CURTAINS FOR PAVILION TENT 3.08 (4 UNITS) INCLUDED WITH TENT 25148 CODE 25151

Pack size: 40x22x11cm - 16"x9"x4"

Price \$ 999,00

YACHTBEACH SPORT PLATFORM 4.10x4.10 GRIP TEAK CODE 25164

Pack size: 118x66x38cm - 46"x26"x15"

Price \$ 3.999,00

YACHTBEACH PAVILION TENT 4.10x4.10 CODE 25165

Pack size: 92x66x52cm - 36"x26"x20"

Price \$ 2.999,00

YACHTBEACH CURTAINS FOR PAVILION TENT 4.10 (4 UNITS) INCLUDED WITH TENT 25165 CODE 25166

Pack size: 50x22x11cm - 20"x9"x4"

Price \$ 999,00

**YACHTBEACH RELAX PLATFORM 4.10x4.10
GRIP TEAK
CODE 25178**

Pack size: 118x66x38cm - 46"x26"x15"

Price \$ 3.999,00



NEW



**RELAX PAVILION
PARTY SETUP 4.10X4.10
CODE 26135**

Price \$ 4.499,00



**RELAX PAVILION
LOUNGE SETUP 4.10X4.10
CODE 26136**

Price \$ 5.999,00

CURTAIN

25166
incl. with Tent 25165



PAVILION TENT

25165
Price \$ 2.999,00

PAVILION SOFA

25185
Price \$ 949,00

PAVILION TABLE

25184
Price \$ 949,00



**RELAX PAVILION
BEACHCLUB SETUP 4.10X4.10
CODE 26137**

Price \$ 8.599,00

PAVILION BACKREST

25186
Price \$ 649,00

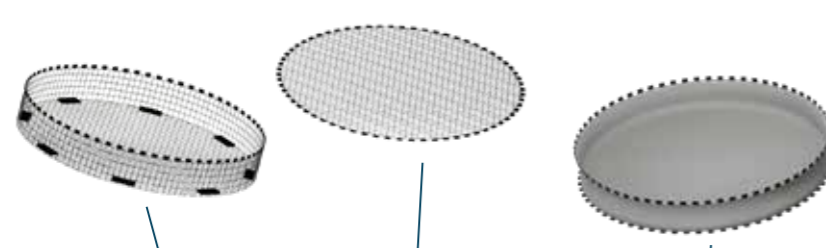
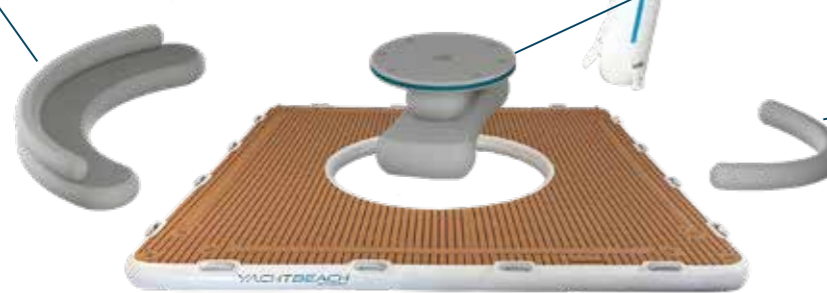

DEEP MESH

25194
enjoy your feet in
the water

Price \$ 399,00

FLAT MESH

25193
allows to sit & lounge
on the water surface
incl. with platform 25178

Price \$ 219,00

FLAT COVER

25192
stay mostly dry
inside the pavilion

Price \$ 329,00

**YACHTBEACH RELAX
PAVILION BEACHCLUB SETUP
4.10 X 4.10**

Measurements:
Pavilion Platform - 410 x 410 cm
Pavilion Tent - 410 x 410 cm

Capacity:
Up to 10 Person

The new Yachtbeach Relax Pavilion Beachclub Setup is an inflatable modular system with platform, tent, table, sofa and backrest. The Yachtbeach Pavilion offers a stylish and weatherproof space that seamlessly combines the charm of the outdoors with the comfort of the indoors. The tent with 4 pillars allowing for optional curtains to be hung.



YACHTBEACH YACHT CONNECTOR SET

Offers multiple ways of connecting Yachtbeach and other platforms towards the Yacht

Measurements:
 Size: 220x100x100cm x 20cm Diameter / 7'2"x3'2"x3'2"x8"
 Pack size: 57x37x30cm - 22"x14"x12"
 Weight: 6,15 kg - 13,6lbs

0,9mm reinforced 1000D PVC
 8 Nautical Handles
 1 x H3 Valve
 Sold in Pairs

Scope of delivery:
 1 x packing bag & 1 x manual
 1 x Repair Kit without glue
 Pump & handle connector pro (21402) are not included

YACHTBEACH YACHT CONNECTOR SET CODE 19751

Price \$ 679,00

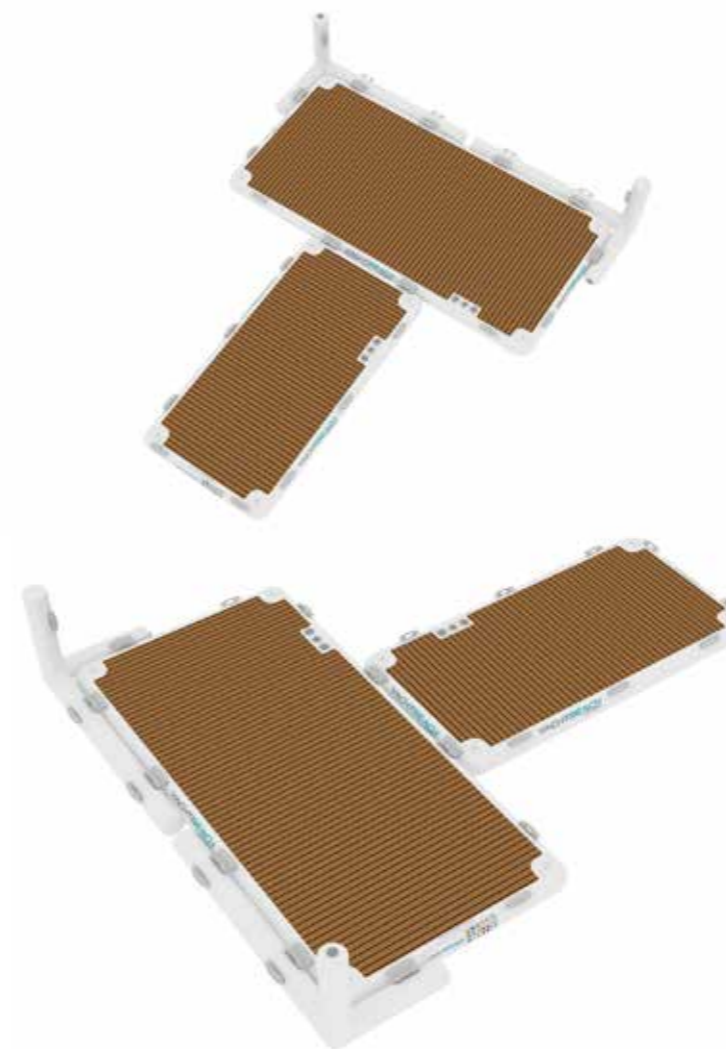

YACHTBEACH JET SKI DOCK

Modular Dock for Jet Skis with connectors
 3.08 + 4.10 Platform with connectors

Measurements:
 Connector:
 Size: 220x100x100cm x 20cm Diameter / 7'2"x3'2"x3'2"x8"
 Pack size: 55x35x30cm - 22"x14"x12"

Platform: 4.10
 616x205cm - 20'x6,7'
 Packing size: approx. 218x36x31cm - 86"x14"x12"

Platform: 3.08
 308x155cm - 10,1'x5'
 Packing size: approx. 166x38x26cm - 65"x15"x10"

YACHTBEACH JET SKI DOCK 3.08 + 4.10 + CONNECTOR SET

Price \$ 7.077,00



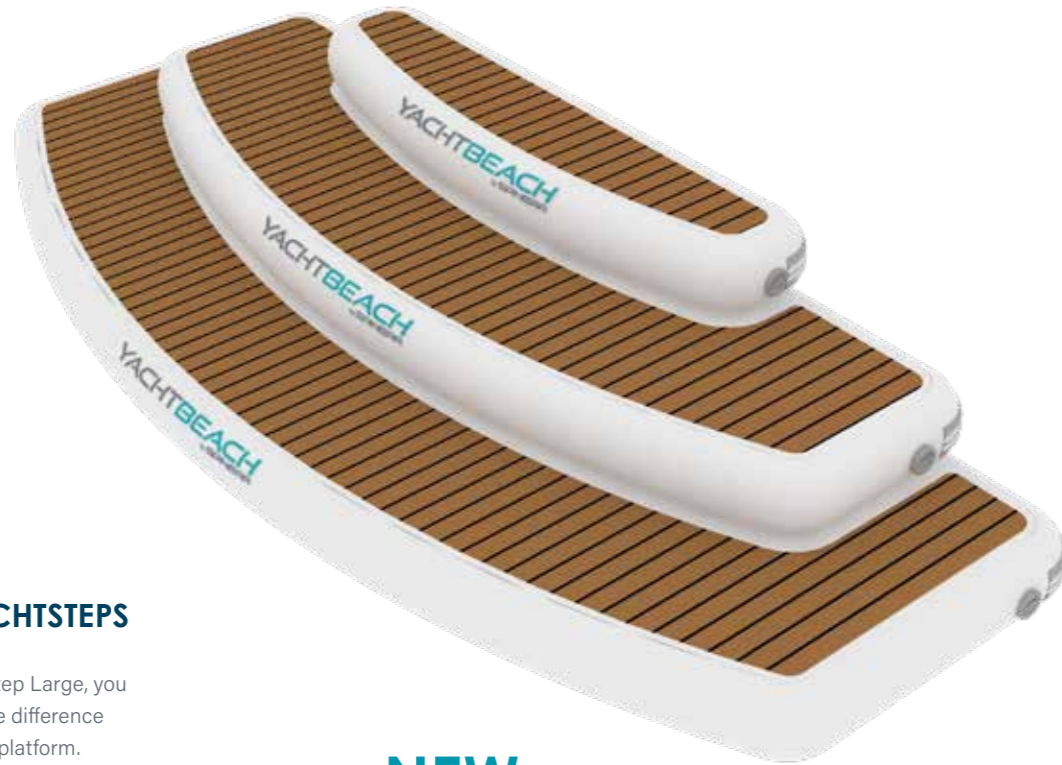

YACHTBEACH YACHTSTEPS

With the Yachtbeach Yachtstep Large, you can effortlessly overcome the difference between your yacht and the platform. The comfortable Yachtstep Large consists of 3 inflatable 20cm dropstitch steps, which are glued together. The high-quality EVA teak surface ensures an elegant look, maximum comfort & safety.

The Yachtstep Large is designed for use with our Yachtbeach platforms and docks and makes getting onto your yacht a breeze. Included are 5 straps, to fix the Yachtstep Large onto almost any platform and a carry bag for easy storage & transportation.

NEW

**YACHTBEACH YACHTSTEP LARGE
CODE 25112**

Price \$ 3.599,00

Measurements:
Size: Lower Step: 343 x 140 x 60 cm - 135,04" x 55,12" x 23,62"
Middle Step: 276 x 95 cm - 108,66" x 37,40"
Top Step: 173 x 50 cm - 68,11" x 19,69"

Pack size: 146 x 50 x 43 cm - 57" x 20" x 17"



NEW

**YACHTBEACH YACHTSTEP MEDIUM
CODE 25111**

Price \$ 1.899,00

Measurements:
Size: Lower Step: 276 x 95 x 40 cm - 108,66" x 37,40" x 15,75"
Top Step: 173 x 50 cm - 68,11" x 19,69"

Pack size: 96 x 43 x 36 cm - 38" x 17" x 14"



NEW

**YACHTBEACH YACHTSTEP SMALL
CODE 25110**

Price \$ 749,00

Measurements:
Size: 158 x 70 x 20 cm - 62,20" x 27,56" x 7,87"

Pack size: 73 x 38 x 23 cm - 29" x 15" x 9"

**HOW TO PLACE YACHTSTEPS
ON 4.10 PLATFORM**

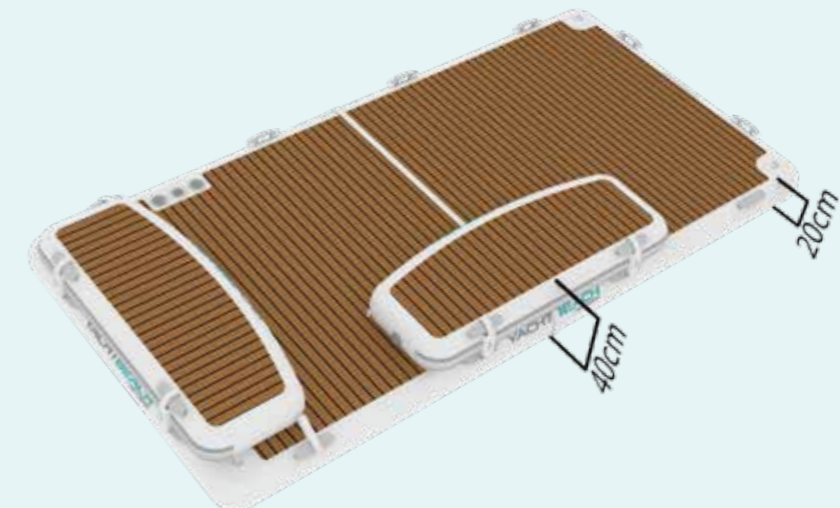
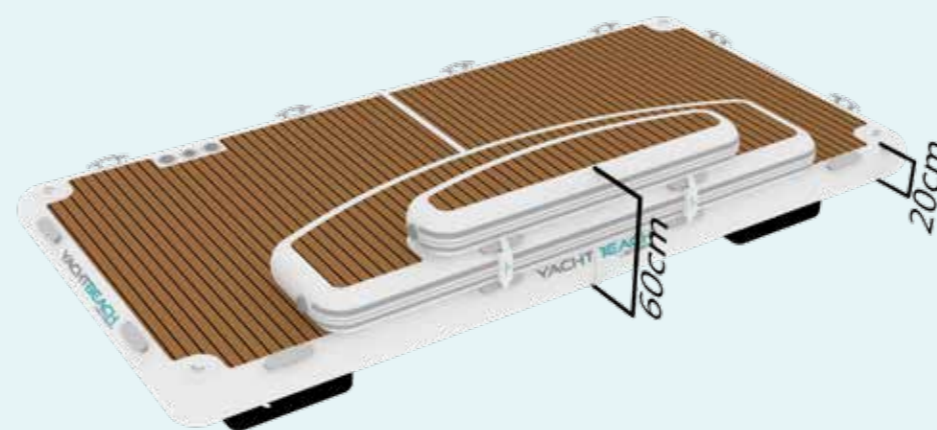
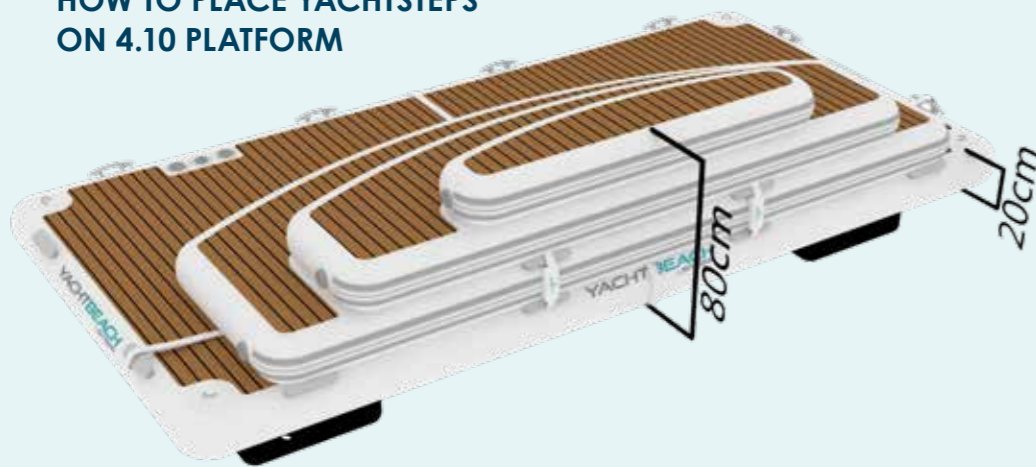

YACHTBEACH MAGIC YACHTSLIDE

Discover the exciting fun on the water with the inflatable Yachtbeach Magic Yachtslides in 6 different sizes – 270-350 cm, 380-460 cm, 460-540 cm, 540-620 cm, 620-700 cm & 700-780 cm.

The Yachtbeach Magic Yachtslides are the perfect addition to your yacht or boat, providing hours of water fun for you, your family and your friends. With their premium design and impressive features, they make for unforgettable moments on the water.

Size Options: We offer the Yachtbeach Magic Yachtslides in three different sizes to suit your individual needs. Choose from the 460-540 cm, or 540-620 cm option for more compact yachts or boats, the 620-700 cm option for mid-sized watercraft, or the 700-780 cm option for larger luxury yachts. No matter which size you choose, water fun for the whole family and friends is guaranteed! Experience the thrill of sliding on the water and create unforgettable memories with your loved ones.

High-quality materials: each Yachtslide is made of durable and high-quality material that ensures long life and reliability. The sturdy seams and reinforced joints ensure that the yacht slide can withstand the rigors of water and use.

Easy to Install: Yachtbeach Magic Yachtslides are easy to inflate and install. With the help of a powerful electric pump, the slides are ready for use in no time. The slide attaches securely to the side of your yacht and provides easy access to the water.

Exciting slides: Yachtbeach Magic Yachtslides are specially designed to provide an exhilarating sliding experience. With their smooth curves and non-slip surfaces, they guarantee a safe and fun ride into the cool water. Young or old, everyone will love the thrill and joy of sliding on the water.

- > Art. 23275 Yachtbeach Mini Slide 175-215 cm
- > Art. 24347 Yachtbeach Magic Yachtslide 270-350 cm
- > Art. 24345 Yachtbeach Magic Yachtslide 380-460 cm
- > Art. 24281 Yachtbeach Magic Yachtslide 460-540 cm
- > Art. 23237 Yachtbeach Magic Yachtslide 540-620 cm
- > Art. 23238 Yachtbeach Magic Yachtslide 620-700 cm
- > Art. 23239 Yachtbeach Magic Yachtslide 700-780 cm



Foto: MY Bina

YACHTBEACH MINI SLIDE

All in one Slide that fits perfect for Boats, Pontoon Boats, Docks or Platforms. The air-steps can be adjusted in angle to ensure the perfect position. This way it fits for railings from 30-70 cm height. Air-steps can even be taken off if you want to put the slide on a flat starting platform. This adjustable system truly makes this slide to be a best fitting universal fun slide.

Measurements:

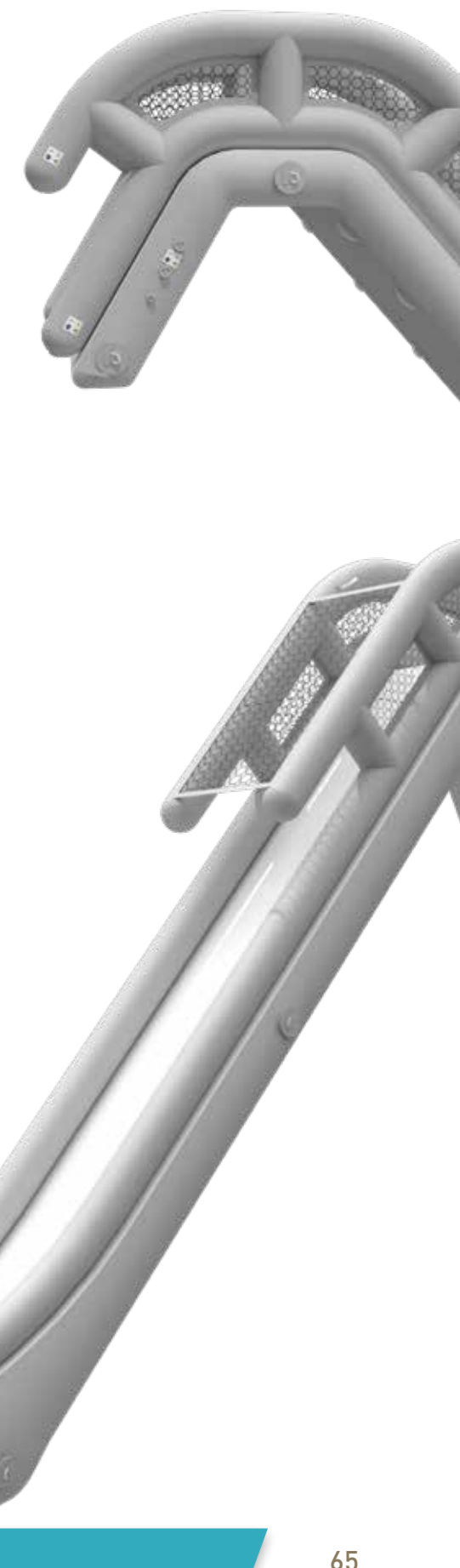
External dimensions:

Total height: 245cm

Slide length: 300cm

Weight incl. bag: approx. 27,5kg - 60,6"

Packing size: approx. 95x51x32cm - 37"x20"x13"

Material thickness:

Reinforced heavy duty pvc

Characteristics:

- > 4 Air Chambers
- > Valve: equipped with 4 high pressure valves which allows a quick and easy filling.
- > PRV: 1 Pressure Relief Valve always ensures the right pressure
- > Handles: 2 high-quality molded handles
- > D rings: various D-rings for perfect adjustment

Scope of delivery:

1x carrying bag

1x repair set without glue

Pump is not included

YACHTBEACH MINI SLIDE CODE 23275

Slide height from top of railing to waterline: 175-210cm - 68,9"x82,7"

Price \$ 3.699,00

**NOW MOSTLY
AVAILABLE AND
ON STOCK!**
in europe

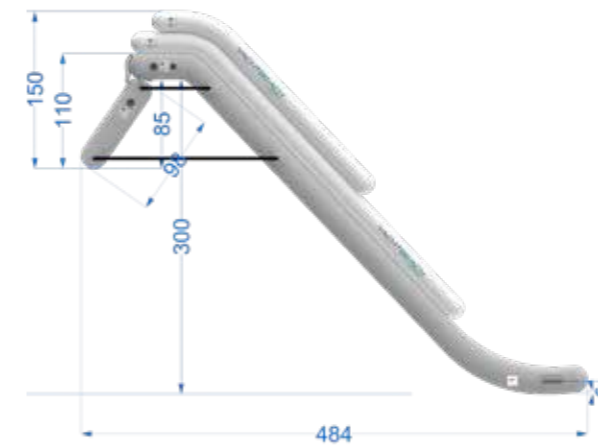
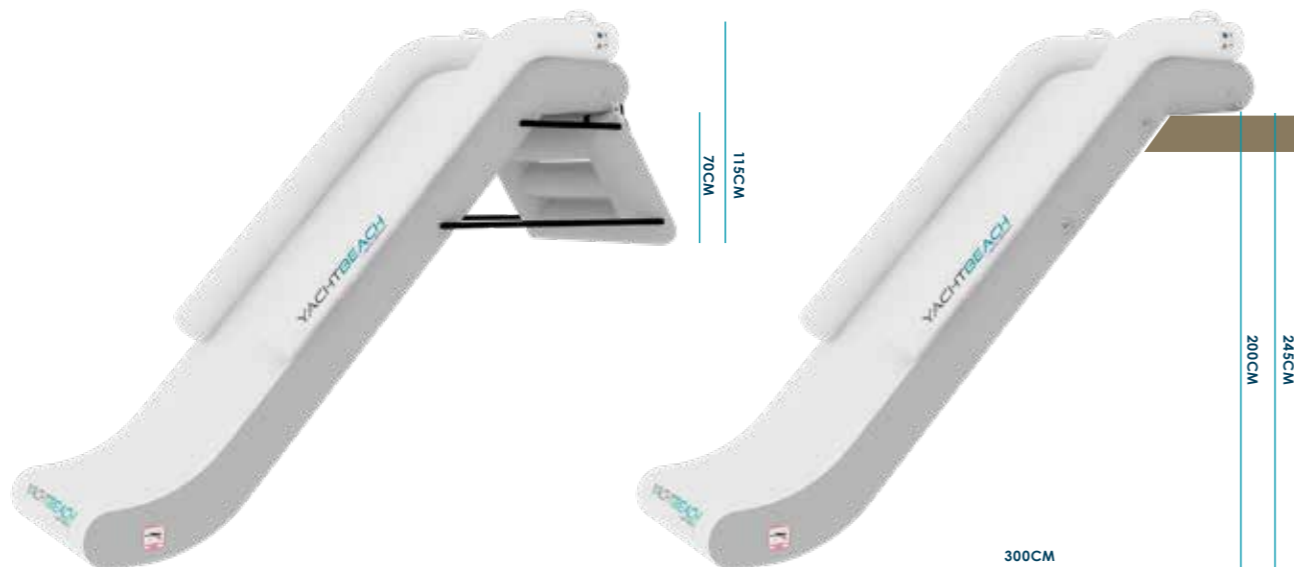

YACHTBEACH SLIDE 270-350CM CODE 24347

Slide height from top of railing to waterline:

270-350cm - 106,3"x137,8"

Packing Size: approx. 96x61x35cm - 38"x24"x14"

Weight inc. bag: approx. 46 kg - 102"

Price \$ 6.299,00



YACHTBEACH SLIDE 380-460CM CODE 24345

Slide height from top of railing to waterline:

380-460cm - 149,6"x181,1"

Packing Size: approx. 110x80x74cm - 43"x32"x29"

Weight inc. bag: approx. 99 kg - 218,3"

Price \$ 9.499,00



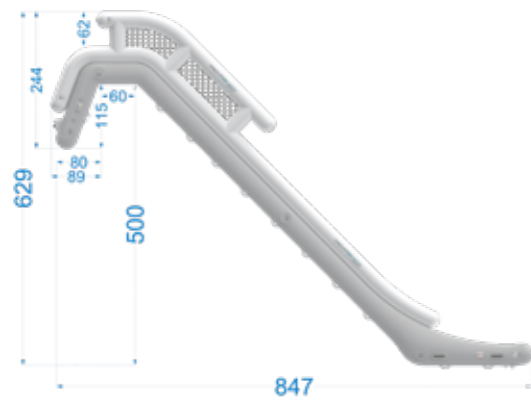

**YACHTBEACH SLIDE 460-540CM
CODE 24281**

Slide height from top of railing to waterline:
460-540cm - 181,1"x212,6"
Packing Size: approx. 110x80x65cm - 43"x32"x26"
Weight inc. bag: approx. 116 kg - 255,74"

Price \$ 9.699,00

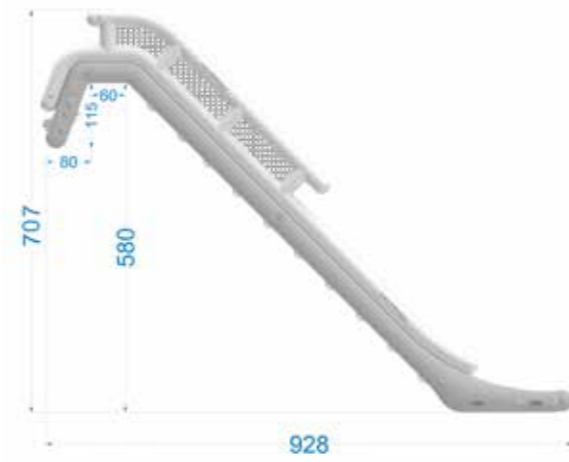

**YACHTBEACH SLIDE 540-620CM
CODE 23237**

Slide height from top of railing to waterline:
540-620cm - 212,6"x244,1"
Packing Size: approx. 110x80x75cm - 43"x32"x30"
Weight inc. bag: approx. 126 kg - 277,78"

Price \$ 9.999,00

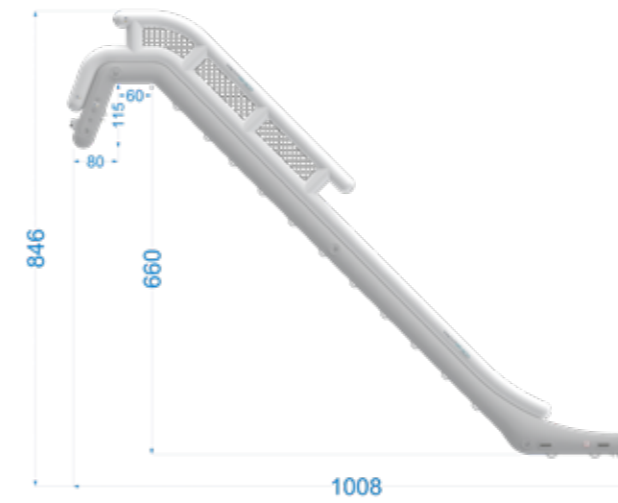

**YACHTBEACH SLIDE 620-700CM
CODE 23238**

Slide height from top of railing to waterline:
620-700cm - 244,1"x275,6"
Packing Size: approx. 110x80x80cm - 43"x32"x32"
Weight inc. bag: approx. 136 kg - 299,83"

Price \$ 11.599,00

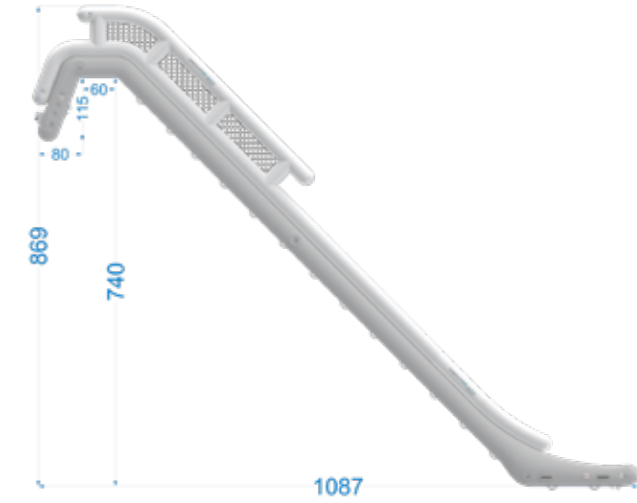

**YACHTBEACH SLIDE 700-780CM
CODE 23239**

Slide height from top of railing to waterline:
700-780cm - 275,6"x307,1"
Packing Size: approx. 110x80x90cm - 43"x32"x35"
Weight inc. bag: approx. 156 kg - 343,92"

Price \$ 12.599,00



YACHTBEACH SHELL SOFA **NEW**

Characteristics:

- > designed for 2 Person
- > Marine leather cover
- > for Deck or Water lounging
- > Strap for attachment on platform or deck included
- > 2 air chambers
- > ready to attach 2 cupholders (24317)

Measurements:

Size: 197x175x74cm - 78"x69"x29"
 Seating area size: 116x102cm - 46"x40"
 Weight: approx. 12,5kg - 27,56lbs
 Packing size: approx. 46,36 x 28,58 x 55,88 cm (18,3" x 11,3" x 22") - 14,5 kg



YACHTBEACH SHELL SOFA CODE 26125

Price \$ 1.399,00





YACHTBEACH AIR SOFA 160

Finest artificial marine leather top
4 Straps to fix on platform

Measurements:

Size: 160x160x65cm - 5'x5'x2'
Depth: 90cm - 35"
Weight: approx. 23,6kg - 52,18lbs
Packing size: approx. 60x46x26cm - 23"x18"x10"

- several configurations for a lounge group are possible
- easily build your ideal lounge for chill and party time
- 4 straps for easy attachment to your yachtbeach

**YACHTBEACH AIRSOFA CORNER 160
CODE 19611**

Price \$ 1.699,00



**YACHTBEACH BENCH 160
CODE 23243**

Measurements:
Size: 160x80cm - 5'x31"
Packing size: approx. 40x23x48cm - 16"x9"x19"

Price \$ 799,00

**YACHTBEACH CHAIR 80
CODE 23242**

Measurements:
Size: 80x80cm - 31"x31"
Packing size: approx. 36x18x48cm - 14"x7"x19"

Price \$ 599,00

**YACHTBEACH STOOL 60
CODE 23244**

Measurements:
Size: 60cm diameter - 23"
• connecting leash included
Packing size: approx. 25x14x34cm - 10"x6"x13"
Price \$ 199,00



YACHTBEACH IN-WATER LOUNGER 102X205 **NEW**

Transform the sea into your personal chill zone with the In-Water Lounger Single – a premium floating hammock designed for both adults and children. Whether securely connected to your YACHTBEACH platform or freely drifting in open water, this modular lounger promises relaxation in its most luxurious form. For additional comfort a soft cushion is included as well as two cup holders to have your favorite drink always in reach.

As part of the YACHTBEACH Modular System, it seamlessly attaches to any platform or dock using robust D-rings and handle connectors. Unpack, inflate, relax – it's that simple.

Measurements:

Size: 102x205cm - 40"x81"

Packing size: 60x42x16 cm - 24"x17"x6"

YACHTBEACH IN-WATER LOUNGER CODE 26104

Price \$ 499,00

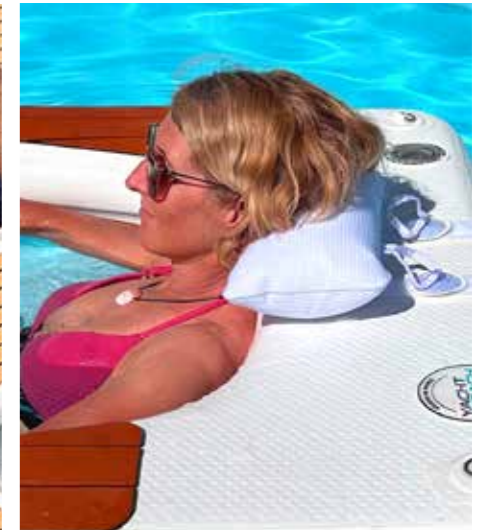
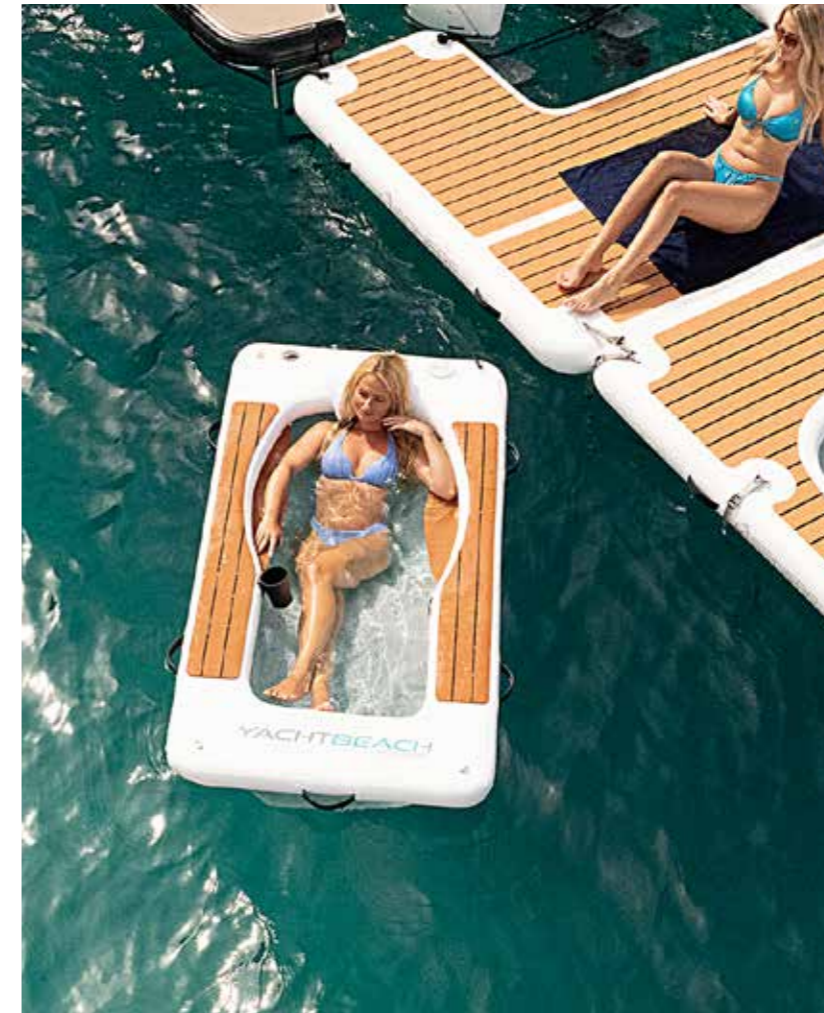
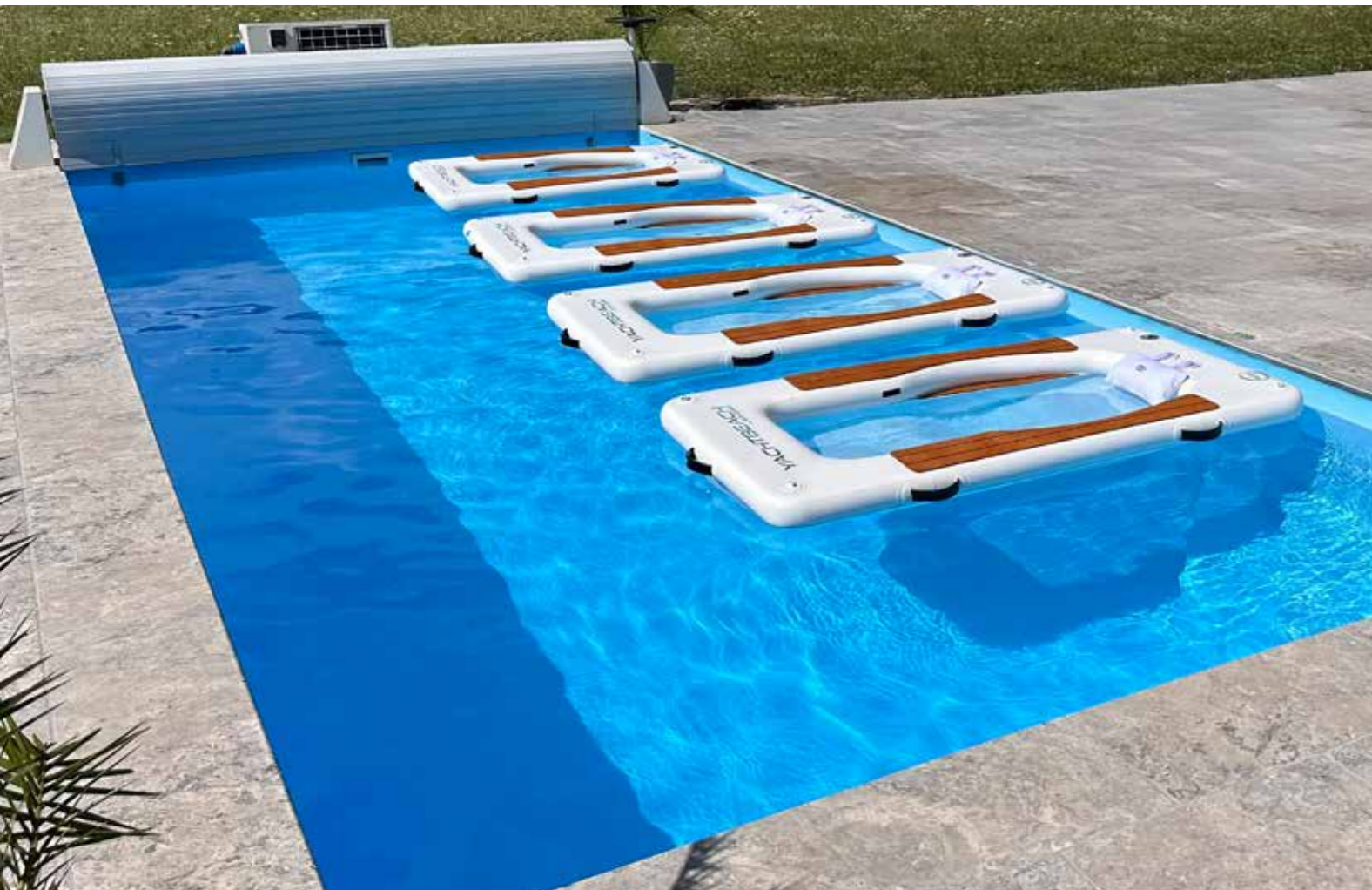

2 x Cupholder included

YACHTBEACH DOUBLE SUNBED

The lounge is an inflatable double sunbed. It is manufactured to withstand the toughest requirements. Our double sunbed is thanks to his heavy duty construction very stable and keeps the shape all the time.

It is also possible to combine the lounge with the sun roof to get the perfect shadow for your relaxing moments.

Measurements:

Size: 220x150cm - 7,2'x5'

Weight incl. bag: approx. 21kg - 46,3lbs

Pack size: 80x46x29 cm - 32"x18"x12"



how to attach the sun roof



YACHTBEACH DOUBLE SUNBED CODE 20328

Price \$ 1.499,00

YACHTBEACH SUN ROOF WITH 2 CONNECTORS

How to keep shadow on the waterline without having a bulky construction and flying parts when the wind blows? Yachtbeach has invented the perfect solution to create a fast and easy way to create your shadow place.

This sunsail get its shape by connected fiberglass poles similar like used in a tent. Patented molded holders that are perfectly connectable with our Yachtbeach Handles make it super stable. Even with upcoming afternoon winds the sail keeps perfect its position. To sum up we developed a nice and easy shadow solution and a must have on every yacht!

Measurements:

Shadow Size: approx. 250 x 150cm

Roof Height: adjustable 130-150cm

Pack size: Poles fold to a pack of aprox 110 x 15 cm

Material thickness:

Nylon / Mesh Sunsail, Fiberglass Poles, molded plastic holders

Compatible:

Fits for all Yachtbeach platforms, Pools, Docks as you need just 2 free Yachtbeach handles to connect

Fits for Yachtbeach Double Sunbed

Can be added towards other inflatables by gluing Yachtbeach Handles on the surface (contact our Sales Team for information)

Scope of delivery:

1x carrying bag



YACHTBEACH SUN ROOF WITH 2 CONNECTORS CODE 24238

Price \$ 419,00

YACHTBEACH SUPERIOR SUN LOUNGER

Yachtbeach Sun Lounger Superior Single 75 x 160 is an inflatable lounger specially designed for use on Yachtbeach platforms, but also perfect for use in the garden and pool. With its generous dimensions of 75 x 160 cm, it offers a comfortable and relaxing seating option on the water and on land. This deck chair is perfect for enjoying the sun and relaxing on the deck of your Yachtbeach platform or in the water. Its inflatable design makes it easy to transport and use, and it is an ideal addition to your leisure time on the water.

Measurements:

Size: 75x160cm

Weight incl. bag: approx. 7kg - 15,43lbs

Pack size: 50x29x27cm - 19,7"x11,2"x10,6"



**YACHTBEACH SUPERIOR SUN LOUNGER
CODE 23246**

Price \$ 649,00



LOUNGING ON THE BEACH



FLOATING IN THE WATER



LOUNGING ON PLATFORM OR YACHT



CUSTOM MADE PRODUCTS

Let us build your dreams together! Yachtslides, climbing walls, pools, docks, or something different? There is NO LIMIT. Yachtbeach offers you uncountable possibilities to create more: space, freedom & fun!

Due to our experience in the watersports and superyacht industry we are able to develop innovative products of highest quality to meet the high demands. Our skilled team from POD International is at your side with help and advice starting from step one.



Material

German companies and their products have a good reputation. We want to comply with this and use only the most innovative and high-quality raw materials for our products. Only fabrics that have passed all tests such as sequencing resistance, UV resistance, riptests, longevity are included in the extensive selection. With our D- rings, we only use saltwater-resistant steel. PVC, PVA are selected according to German standards. Durability, highest quality and material is our priority.

Branding

No wish remain unfulfilled at Yacht beach, we can place the name of your yacht freely on your platforms on request. Your yacht appears including the Water toy area in one color and style if needed. We can place the name of your yacht, or a logo on any design on request – no wish remain unfulfilled at Yachtbeach

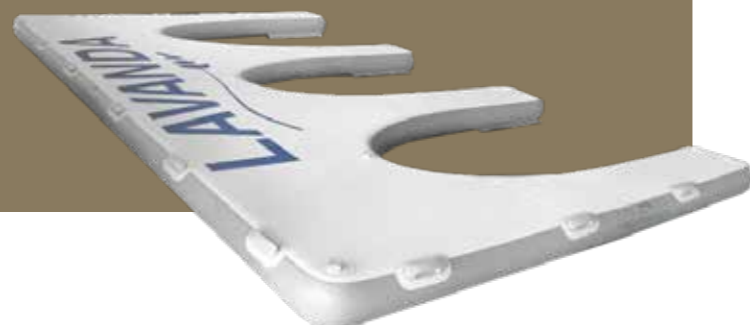

Surface

EVA surface: soft and very comfortable material

Anti Slip surface: smaller in storage and suitable for projects where you would need more grip (work platforms, walkways etc.)

On bigger projects we also fully glue the surface material as it is easier to clean and care for. It also assures a flat looking EVA.

Choose from different surface options:

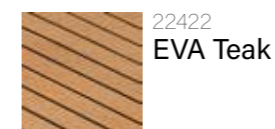

22422
EVA Teak



22424
Anti Slip
sanded PVC
white



22423
Anti Slip
sanded PVC
grey



22425
Anti Slip
sanded
brown, black teak

Custom-made products without compromises

All products can be customized and combined with each other, due to our fast and very strong handle connection system. Our experienced team is able to provide you within 1-2 days 3D renderings, that will perfectly fit to the rear of the yacht.

All bigger customized product will have 2 valves, in this way you can work with 2 hoses to inflate the product, which allows approx. 50% faster inflation. If you have 2 pumps the inflation will obviously be 100% faster.

Welcome to the world of floating luxury!

The set up of Yachtbeach platforms is soo easy! Due to lightweight, very robust and durable materials, we reduce weight in the right places to make a very easy build-up.

The theme of set-up is 100% based on simplicity for crew and people who are busy with the assembly and dismantling. Crew suggestions help us to bring the Yachtbeach products further forward and to stand out through design, innovation, durability and crew friendliness. Because the Yachtbeach team deliberately includes these phases in their development process.

Yachtbeach Custom is the realization of any idea that a customer addresses to us. Starting with the contact, very fast processing, over the solution finding up to the logistics with air freight.

On request, a Yachtbeach Instructor will be happy to look after your crew and give advice on the set-up, set-down, storage and care of Yachtbeach products, if needed.



HIGH QUALITY PRODUCTS

CUSTOM JETSKI AND TOY DOCKS

You need a space for all your watertoys which fits your needs exactly? We can make your dream come true and design the dock as you need it.

Create space for your Jetski, e-board, foil board, dive scooter, or would you need a work platform, or in general more space on the water? We have the solution for you - our platforms are made of 20cm high quality drop stitch material and simple to install, to remove and even to transport. Within minutes one platform is inflated and ready to float. D-rings, handles, bumpers, bathing ladders can be added as needed and of course, a branding with your yachts name or logo is possible as well.

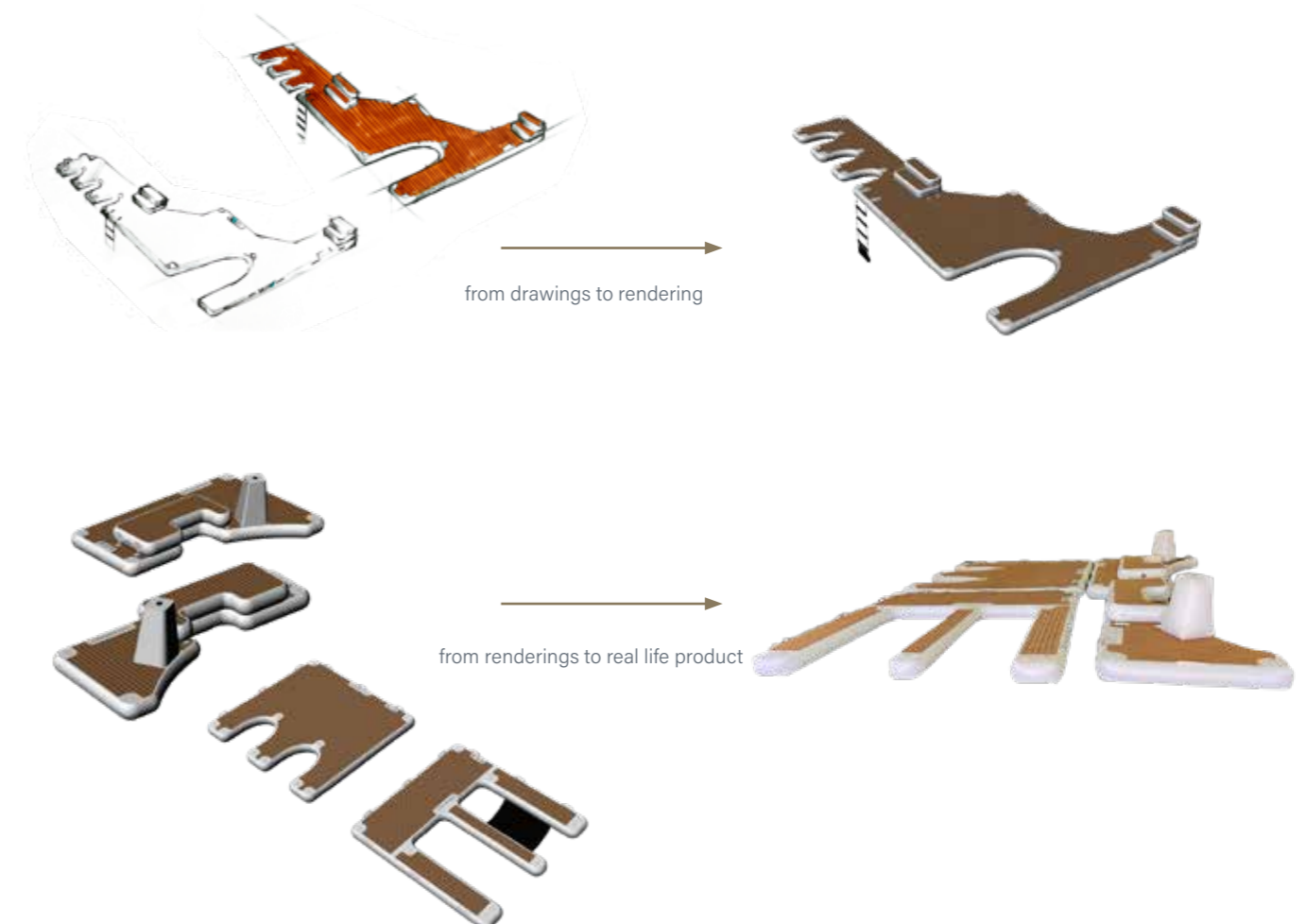

CUSTOM SLIDE

Yacht slides are incredibly popular with guests and a perfect add on to any yacht. Our team has designed and installed hundreds of slides on yachts in the world. All slides are custom fitted to each yacht, a logo, or kicker can be added as well. We are glad to provide a solution for a custom slide, that will perfectly match to the colourways of your yacht and that will make installation easy for the entire crew.



CUSTOM GATEWAY

Our custom gateway is designed to perfectly match to the rear of the yacht no matter whether the shape of the yacht is concave, curved or straight. Together with our experienced team we could guarantee a perfect match without any compromises. Directly from the gateway you could dock onto any Yachtbeach stock products (such as foil dock, jetski dock, platform, multi dock etc.) or to any custom dock or platform, so you could create more space, freedom and fun behind your yacht!



CUSTOM POOL

Yachtbeach Custom Pools are made to ensure maximum safety against unwanted sealife, such as jellyfish or other creatures and provide more fun and comfort at your boat.

20cm high quality drop stitch material ensures maximum stability to walk around, or to have some additional space to lounge. We try to keep storage as minimal as possible. Bigger pools can be made out of more pieces, which makes handling for the crew easier. Our experienced team, which is very close in contact with a lot of different crew members will work out the perfect solution for your yacht.

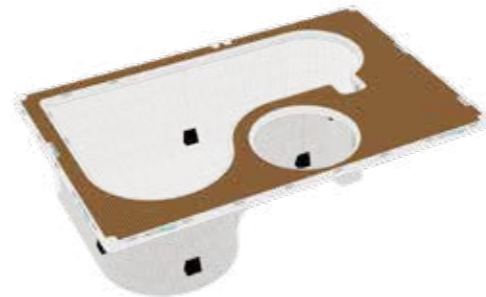

CUSTOM TOY DOCK

Individual setup configuration for all the watertoys you need space for. The different dockings for specific products can be arranged as you need it with the help of our team.



CUSTOM PICKLEBALL COURT

The first inflatable pickleball court for yacht and events.

Experience the thrill of pickleball like never before – on water.

The YACHTBEACH Inflatable Pickleball Court brings one of the world's fastest-growing sports to the sea, lake, or beach in a luxurious and innovative way.

Whether floating behind a yacht or set up onshore at an event, resort, or beach club, this inflatable court turns any waterfront location into a premium sports arena.



Foto: MY Bina



YACHTBEACH BOARDING LADDER FOR HEX PLATFORMS
CODE 23211

Price \$ 69,00



BOARDING LADDER

Weight: 3,9 kg

Code 19610
Price \$ 519,00



SUPERIOR LADDER
CODE 25133

Folded dimensions: 56 x 80 x 38 cm
Weight: 11 kg
Unfolded length: 156 cm,
38 cm wide with screw

Price \$ 1.099,00



ELITE CARRY BAG
CODE 25203

Size: approx. 230 x 45 cm

Price \$ 139,00

NEW



YACHTBEACH CUPS & BUCKETS

The Set contains one bucket and eight cups

Code 23224

Price \$ 99,00



YACHTBEACH FLOATING 5 CUP HOLDER

Code 20363

Price \$ 139,00



YACHTBEACH FLOATING 11 CUP HOLDER

Code 23227

Price \$ 319,00



HANDLE CONNECTOR PRO

Material: 0,9mm 1000D/28x26 Reinforced PVC

Inside with 1,5" Stainless Steel Buckle

Weight: 0,15 kg

Code 21402

Price \$ 29,00



VELCRO D-RING CONNECTOR

Heavy Duty Connection Strap to connect 2 D-Rings

1.5" Strap, length is about 118cm

Perfect to connect 2 D-Rings with up to 55cm distance

Professional 1.5" Stainless Steel #316 Buckle

Code 23228

Price \$ 59,00



HOW TO USE PUMP WITH TWO VALVES

Speed up the install/de-install time with our y- connector

- 1 Pump
- 2 Y-connector
- 3 Hose
- 4 Hose

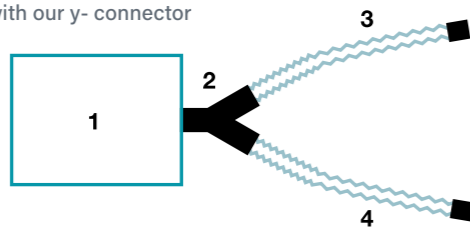

3M HOSE

Size: 36cm x 36 cm x11cm
Weight: 0,8kg
incl. fittings for HR valve

Code 20463
Price \$ 79,00



2M HOSE

Size: 36cm x 36 cm x11cm
Weight: 0,8kg
incl. fittings for HV260 only

Code 20465
Price \$ 89,00



10M HOSE

Size: 40x20 cm
Weight: 0,8kg
incl. fittings for HR valve

Code 20464
Price \$ 189,00



Y CONNECTOR

Size: 40x20 cm
Weight: 0,8kg
for 230V resort pump

Code 20466
Price \$ 29,95



230V PERFORMANCE PUMP

230 V 3.6 PUMP, 3.6 PSI / 0,25 BAR
Especially designed to inflate Yachtbeach bathing platform and Aquaparks, 1700l/min

Pump includes (180052 Adapter) and matches this way Bosten Valve and almost any kind of bayonet valves.

Code 24319
Price \$ 159,95



230V RESORT PUMP

Weight: 5,4kg
Cord: 3m, Inflates and deflates,
Voltage: 230V (120V) mainmotor,
Voltage: 230V (120V) booster
Output: 1200l/min mainmotor, 2000l/min booster,
Pressure: 140mbar (2.0 PSI) mainmotor, 350mbar (5psi)booster

Code 23240
Price \$ 419,95



SPINERA DS PRO AIR PUMP WITH INTEGRATED BATTERY, 25 PSI

25 PSI - 200L/min 300W
Battery Capacity: 10000mAh
The multi function rechargeable pump, can be used to inflate a variety of items, such as paddle boards, kayaks, towables, platforms, docks etc. With it's high airflow volume of 200L/min & the four cylinder you can inflate various products very fast. inflate approx. up to 8 SUPs on a full charge.

Code 24262
Price \$ 439,95



SPINERA SUP5 HIGH PRESSURE 12 V PUMP - 16 PSI

12V - 16 PSI
Airflow Two Modes: 350l/min Fast Filling 110W & 70l/min high Pressure 100 W
Inflate & Deflate
DC car cigarette & DC Normal Plug Charger, 6000mAh rechargeable lithium battery
LCD Display, Variable PSI Selection, 2 USB to use as power bank, LED Lights

Code 24329
Price \$ 299,95



REPAIR GLUE FOR PVC

1 Component, 24ml

Code 197020
available in europe only



REPAIR GLUE FOR PVC

2 Component, 125ml

Code 180520
available in europe only



REPAIR GLUE FOR EVA

2 Component, 125ml

Code 26147
available in europe only



YACHTBEACH POP-UP STRAIGHT WALL STOCK & CUSTOM



Size: 300x228 cm
Code 24367
Price \$ 299,00

YACHTBEACH POP-UP STRAIGHT WALL STOCK & CUSTOM



Size: 400x228 cm
Code 24368
Price \$ 399,00

YACHTBEACH POP-UP C-WALL STOCK & CUSTOM



Size: 228x322 cm
Code 24290
Price \$ 299,00

YACHTBEACH POP-UP STRAIGHT WALL PAVILION AND RESORT



Size: 300x228 cm
Code 25162
Price \$ 299,00

YACHTBEACH X STAND STOCK & CUSTOM

Size: 177,5x59 cm
Code 25161
Price \$ 69,00



YACHTBEACH ROLLUP STOCK

Size: 200x85cm
Code 23231
Price \$ 69,00



YACHTBEACH ROLLUP CUSTOM

Size: 200x85cm
Code 23230
Price \$ 69,00

YACHTBEACH BANNER

Size: 300x80cm
Code 19705
Price \$ 59,00



EVENT TENT FRAME

incl Carry bag
Size: 3x3m
Code 1370101
Price \$ 399,00



YACHTBEACH BEACHFLAG

Size: Pole 431x80cm
Flag 315x75cm
Code 19704
Price \$ 99,00



YACHTBEACH EVENT TENT

Cover only
Size: 3x3m
Code 19699
Price \$ 399,00



CARPET SMALL

Size: 85x60 cm
Code 24239
Price \$ 59,00

CARPET LARGE

Size: 170x120 cm
Code 24240
Price \$ 249,00



YACHTBEACH PLATFORM STAND

for shows & exhibitions
Code 23233
Price \$ 149,00





JETXTENDER - EXTEND YOUR JET SKI

Jet Ski or Dinghy? BOTH!

Have the ultimate fun on your Jet Ski with space for 6 more people! This innovative Jet Ski extension is the biggest party on the water! EU Certification as a boat!

JETXTENDER is an indispensable accessory for your Jet Ski. It looks and feels like a regular inflatable boat, but attaching it to a Jet Ski means no more outboard motor! Jet Ski owners love speed and manoeuvrability, but miss the room to take more passengers along. The JETXTENDER offers them the best of both worlds.

JETXTENDER is light and packs up so small that you can carry it on your Jet Ski. It inflates in just moments and is easy to attach. You can ride it with agility through very shallow waters. JETXTENDER also works great at both - high and low speeds, making it unrivalled in both - recreational or rescue applications.

With the Jetxtender you can take 6 people at maximum with you plus the additional person on the Jet Ski.

You can use it with any other Jet Ski, for extra space, buoyancy, stability, safety or visibility.

YOU WILL LOVE THIS GADGET!

SCAN ME

for a video





YACHTBEACH JETXTENDER 380

The JETXTENDER is a unique water vessel. It becomes your unique specimen.

Individual appearance for rescue, fire and military.

For watersport stations, JETXTENDER offers perfect transport options. With striking design and concise advertising message, your station becomes an eye catcher.

L 380cm x W 240cm
 Jetxtender pack size: approx. 110x52x59cm - 43"x20"x23"
 Weight with bag and pump: 42 kg - 92,5lbs
 Jetxtender 380 Welded and White
 for 6 people just on Jetxtender + people on Jet Ski



JETXTENDER - EU CERTIFICATION AS A BOAT
 FUN WITH YOUR JET SKI FOR UP TO 6 ADDITIONAL GUESTS ON THE JETXTENDER



INDIVIDUAL DESIGN -
 WATERSPORT STATION,
 RESCUE, FIRE, MILITARY...

JETXTENDER 380
CODE 19609

Price \$ 2.699,00

ALSO TAKE A LOOK TO:

SPINERA
PROFESSIONAL

AQUAPARK PRODUCTS FOR

YACHT & BEACH



YACHTBEACH
by SPINERA



More infos about Aquapark Products are in the Spinera Catalog:



Spinera Professional Aquapark features leave no dreams unfulfilled and offer action-packed jumping and climbing as well as the ability to slide down multiple slides into the water. All this directly behind a yacht or as a stand alone item at a lake or beach.

WIDE RANGE FOR AQUAPARK PRODUCTS FROM SPINERA FOR YOUR YACHT



www.spinera.com





YACHTBEACH

by SPINERA



Distributed within USA by
Spinera USA Corp.
PO Box: 1362 U.S. Hwy 395 N Ste 102 #616,
Gardnerville, NV 89410
office.usa@spinera.com

Distributed globally by POD International
Kapellenweg 31, 83064 Raubling, Germany
info@pod.international - Tel. 0049 8035 963929
www.pod.international

Edition 1